

E-Series

Euro Battery Connector / Euro-Batteriestecker

Connectors for Industrial Vehicles / Stecker Für Industriefahrzeuge

- Up to 400A • Meets or Exceeds EN1175:2020, VDE 0623-589 • RoHS Compliant
- Acid & Impact Resistant • Industrial Applications
- Bis zu 400A • Erfüllt oder übertrifft EN1175:2020, VDE 0623-589 • RoHS-konform
- Säure-und schlagfest • Industrieanwendungen



EURO BATTERY CONNECTOR

The Anderson™ family of Euro Battery Connectors (EBC) are expertly designed for ease of use and incorporate an innovative contact carrier to simplify assembly. The EBC connectors include the industry standard 80, 160, and 320 sizes, all in accordance with VDE 0623-589. Design and materials offer performance that meets or exceeds all the requirements of EN1175:2020. All Materials chosen are RoHS compliant and selected to ensure years of reliability in adverse industrial environments. These attributes make the EBC connectors the ideal choice for a wide range of industrial applications in Material Handling, Battery Charging, Utility Vehicles, Motive Power, and Sweepers/Scrubbers amongst many others.



KEY ATTRIBUTES

Safety Agency Approvals

EN1175:2020  File No. E26226

Meets VDE 0623-589, completely compatible with DIN 43589-1

Offers interface compatibility for housings, contacts and air tubes.

Voltage Keying

EBC connectors offer keys for Dry-Cell, Wet-Cell, and Universal applications coded for 24/36/48/72/80 and 96 volts DC applications.

Sturdy Advanced Polymer Housings

Provide superior resistance to impact, acid and temperature extremes.

Silver Plated Copper Contacts

Provide excellent conductivity and superior mating cycle performance.



SPECIFICATIONS

ELECTRICAL

Current Ratings (Amperes)

Wire Size:	E80			E160			E320		
	EN1175	CNR	USR	EN1175	CNR	USR	EN1175	CNR	USR
10 mm ²	N/A	70	90	N/A	N/A	N/A	N/A	N/A	N/A
16 mm ²	80	90	120	80	90	120	N/A	N/A	N/A
25 mm ²	120	110	140	120	120	160	N/A	N/A	N/A
35 mm ²	160	120	160	160	140	180	N/A	N/A	N/A
50 mm ²	N/A	N/A	N/A	250	160	220	250	165	220
75 mm ²	N/A	N/A	N/A	N/A	N/A	N/A	N/A	200	260
95 mm ²	N/A	N/A	N/A	N/A	N/A	N/A	400	260	340

NOTE: All auxiliary contacts regardless of wire size are rated to a Min 20 amps when tested to EN1175:2020 testing requirements.

•EN1175:2020 allows for maximum temperature rise = 65°C (above 25±5°C ambient)

•CNR allows for maximum temperature rise = 30°C

•USR allows for total temperature (based on min. 25°C ambient) = 75°C

Voltage Rating

	EBC 80			EBC 160			EBC 320		
	EN1175	CNR	USR	EN1175	CNR	USR	EN1175	CNR	USR
AC / DC	150V	600V	600V	150V	600V	600V	150V	600V	600V
DWV (AC)	2000	2200	2200	2000	2200	2200	2000	2200	2200

Wire Range	EBC 80		EBC 160		EBC 320	
	mm ²	AWG	mm ²	AWG	mm ²	AWG
Power- Min.	10	8	16	6	50	1/0
Power- Max.	35	2	50	1/0	95	4/0
Upper Aux.- Min.	1.5	18	4	12	4	12
Upper Aux.- Max.	2.5	14	4	12	4	12
Lower Pilot Aux.- Min.	1.5	18	6	10	6	10
Lower Pilot Aux.- Max.	2.5	14	6	10	6	10

Average Initial Contact Resistance Across Mated Connector Micro-ohms

	EBC 80	EBC 160	EBC 320
Avg. Contact Resistance- Power	176	95	77
Avg. Contact Resistance- Aux.	1100	920	1000

Operating Temperature (all Series):-20 to 105°C

MECHANICAL

Life Cycle - Per EN1175:2020

	EBC 80	EBC 160	EBC 320
No Load	>5000	>5000	>5000
Under Load (Hot Plug at 96V)	5 at 400A	5 at 625A	5 at 1000A

Miscellaneous Data

	EBC 80	EBC 160	EBC 320
Avg. Mating Force N (lb)	68 (15.3)	170 (38.2)	71 (16.0)
Contact Retention N (lb)	134(30) min	445(100) min	445(100) min
Degree of Protection	IP23	IP23	IP23
Acid Resistance per EN1175:2020 (1.40g/cm ³ at 20°C)	Passed	Passed	Passed
Air Tube Max Pressure Bar (PSI)	0.8 (11.6)	0.8 (11.6)	0.8 (11.6)
Flammability	UL94 V0		

MATERIALS

EBC 80 - EBC 160 - EBC 320

Housings	PBT/PC Blend
Contacts	Copper Alloy
Contact Plating Power (min.)	Silver Plating - 6 microns
Contact Plating Auxiliary (min.)	Silver Plating - 6 microns
Hardware	Steel, Zinc Chromate

TEMPERATURE CHARTS

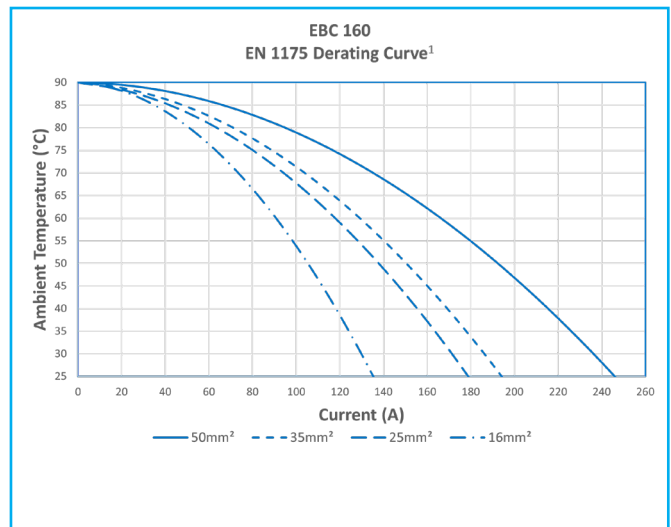
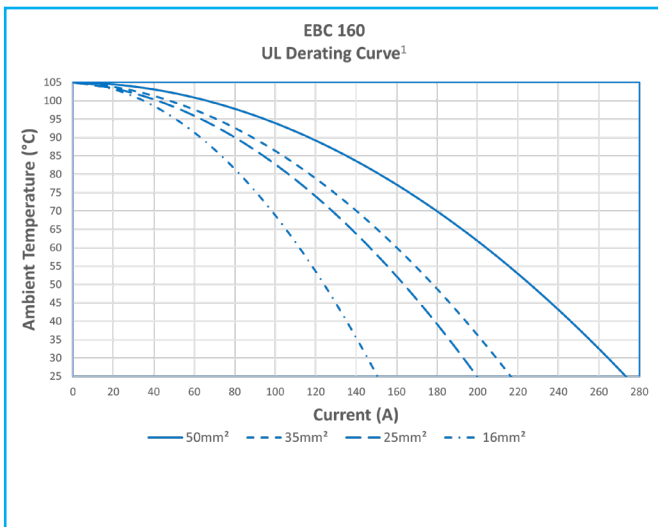
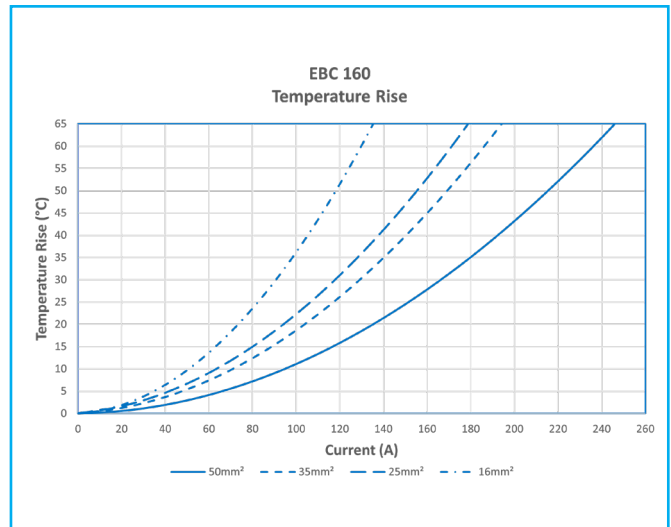
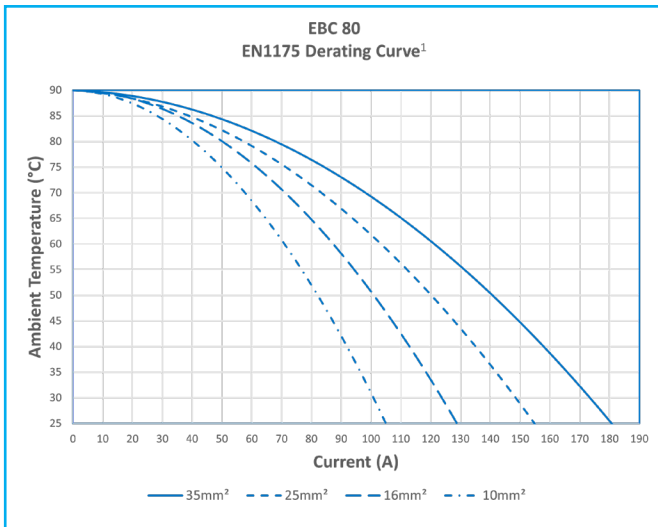
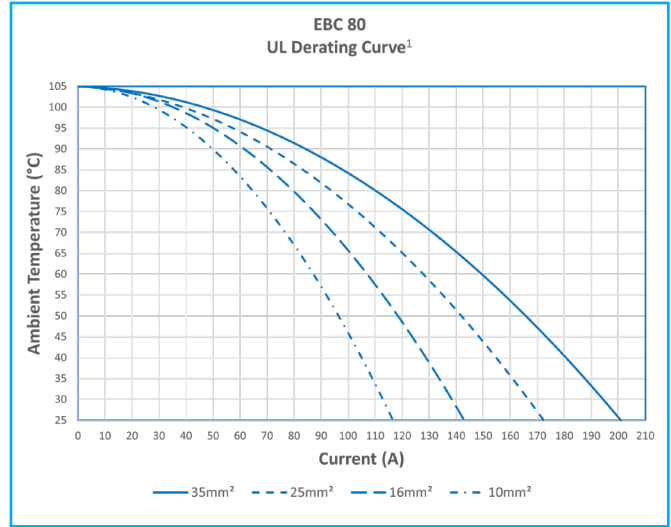
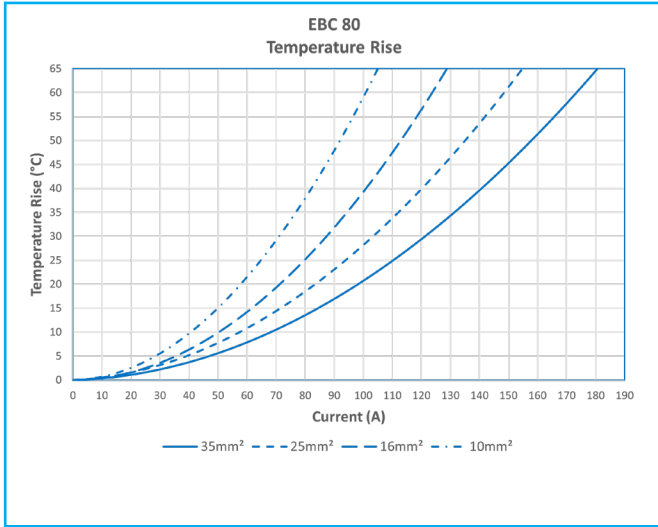

¹ 0.8 Derating per IEC 60512-3

NOTE 1: Temperature ratings based on power contacts energized only.

NOTE 2: Temperature rise charts are based on a 25°C ambient temperature.

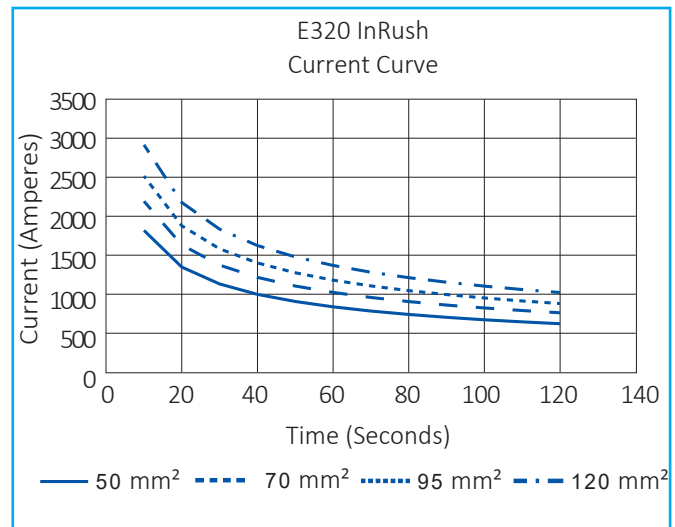
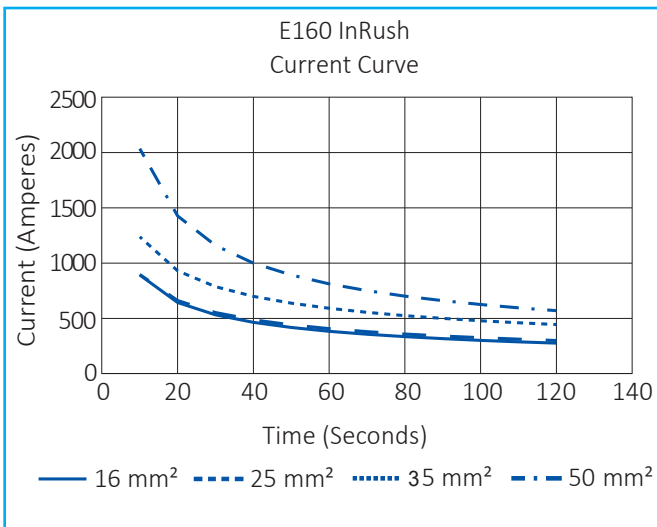
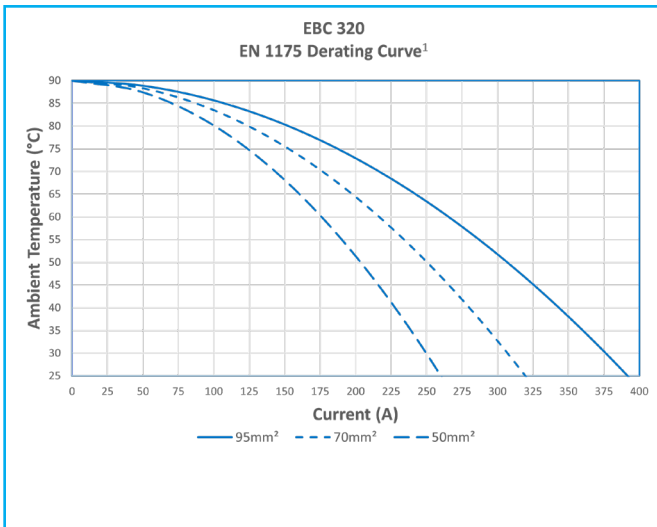
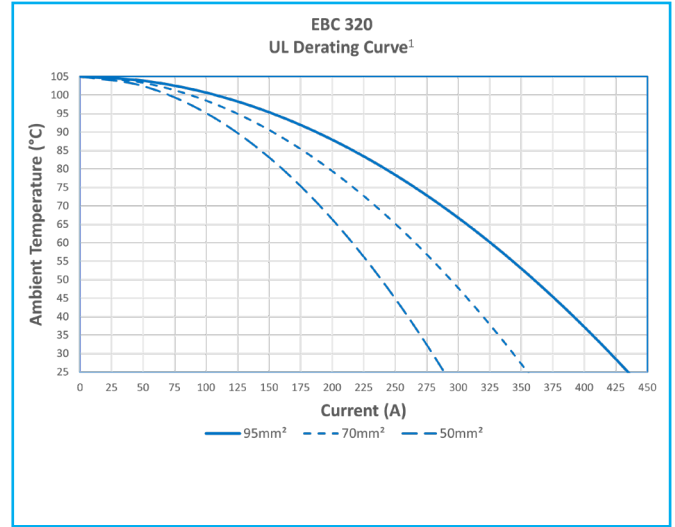
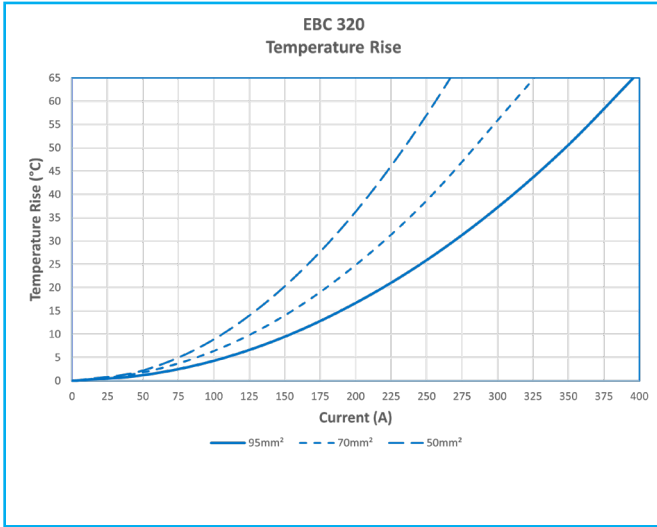

ORDERING INFORMATION

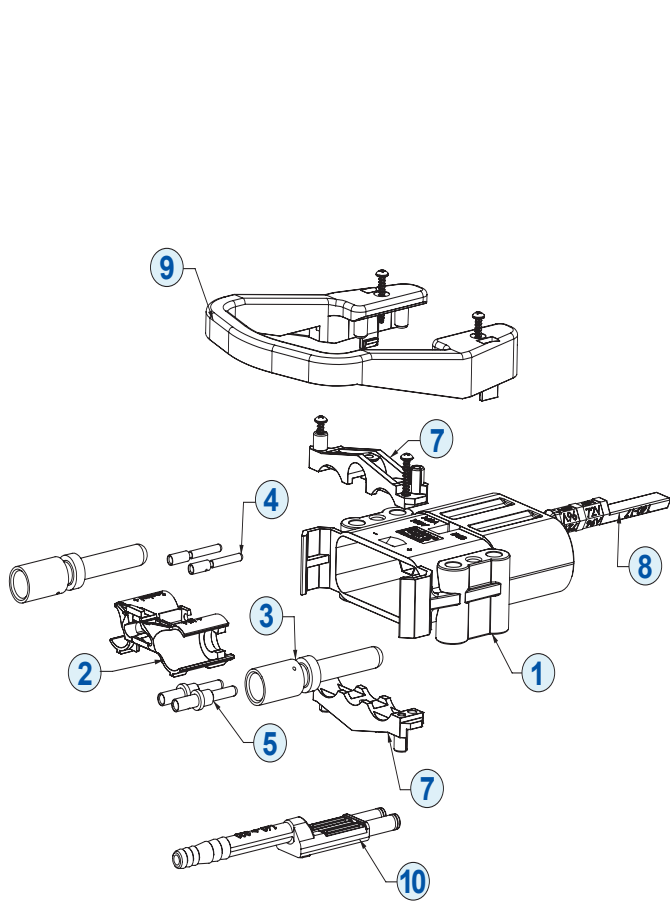

Male Connector

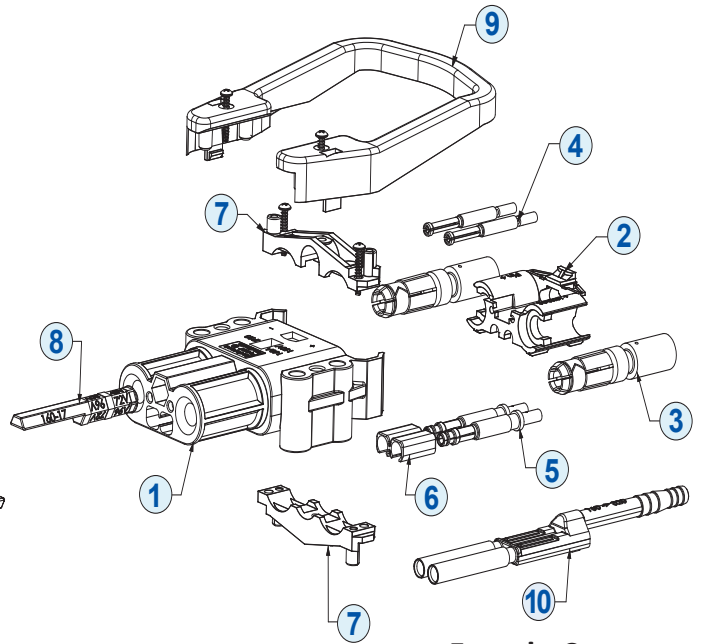

Female Connector

Components

Item Number	Description	EBC 80		EBC 160		EBC 320	
		Male	Female	Male	Female	Male	Female
3	Power Contacts						
	10 mm ² (8 AWG)	80-1010	80-1110	N/A	N/A	N/A	N/A
	16 mm ² (6AWG)	80-1016	80-1116	160-1016	160-1116	N/A	N/A
	25 mm ² (4 AWG)	80-1025	80-1125	160-1025	160-1125	N/A	N/A
	35 mm ² (2 AWG)	80-1035	80-1135	160-1035	160-1135	N/A	N/A
	50 mm ² (1 AWG to 1/0)	N/A	N/A	160-1050	160-1150	320-1050	320-1150
	70 mm ² (2/0 to 3/0)	N/A	N/A	N/A	N/A	320-1070	320-1170
	95 mm ² (3/0 to 4/0)	N/A	N/A	N/A	N/A	320-1095	320-1195
4	Upper Auxiliary Contact	E80-32	E80-33	E160-32	E160-33	E320-34	E320-35
5	*Lower Auxiliary Contact	E80-30	E80-31	160-12	160-13	160-12	160-13
8	Voltage Coding Pins						
	Grey Coding Pin- wet (160 and 320 use same Coding Pins)	80-9	80-9	160-9	160-9	160-9	160-9
	Green Coding Pin- dry (160 and 320 use same Coding Pins)	80-17	80-17	160-17	160-17	160-17	160-17
	**Yellow Coding Pin- univ (160 and 320 use same Coding Pins)	80-19	Not Used	160-19	Not Used	160-19	Not Used
	Blue Coding Pin- Type II dry (160 and 320 use same Coding Pins)	80-22M	80-22F	160-22M	160-22F	160-22M	160-22F
	Red Coding Pin- Type II wet (160 and 320 use same Coding Pins- Contact Factory)	80-23M	80-23F	160-23M	160-23F	160-23M	160-23F
9	***Handle- High Profile w/screws	N/A	N/A	E320-89	E320-89	E320-89	E320-89
	***Handle- Low Profile w/screws	E80-89	E80-89	E160-89	E160-89	E160-89	E160-89
	Handle Red- Low Profile w/screws	80-8-R	80-8-R	N/A	N/A	N/A	N/A
10	*Air Tube	E80-20	E80-21	E160-20	E160-21	E320-20	E320-21
1	Housing Only	EP80-1	EP80-2	EP160-1	EP160-2	EP320-1	EP320-2
2	Contact Holder	80-5B	80-5B	EP160-5	EP160-5	EP320-5	EP320-5
6	Supplemental Lower Pilot Aux Holder	Not Used	Not Used	Not Used	EP320-38	Not Used	EP320-38
7	Cable Clamps with w/screws	EP80-67	EP80-67	EP160-67	EP160-67	EP320-67	EP320-67
1+2+7+8	Male Housing with Contact Holder and Cable Clamp w/screws (Gray Key) - Individual Pack	E80400-0009		E16400-0009		E32400-0009	
1+2+6+7+8	Female Housing with Contact Holder and Cable Clamp w/screws- (Grey Key)- Individual Pack	E80500-0009		E16500-0009			
1+2+7+8	Male Housing with Contact Holder and Cable Clamp w/screws (Green Key)- Individual Pack	E80400-0209		E16400-0209		E32400-0209	
1+2+6+7+8	Female Housing with Contact Holder ****Lower Pilot Aux Holder, Cable Clamp w/ screws- (Green Key)- Individual Pack	E80500-0209		E16500-0209		E32500-0209	
1+2+7+8	Male Housing with Contact Holder and Cable Clamp w/screws (Yellow Key)- Individual Pack	E80400-0309		E16403-0309		E32400-0309	
1+2+7+8	Male Housing with Contact Holder and Cable Clamp w/screws (Blue Key) - Individual Pack	E80400-0409		E16400-0409		E32400-0409	
1+2+6+7+8	Female Housing with Contact Holder ****Lower Pilot Aux Holder, Cable Clamp w/ screws- (Blue Key)- Individual Pack	E80500-0409		E16500-0409		E32500-0409	
1+2+7+8	Male Housing with Contact Holder and Cable Clamp w/screws (Red Key) - Individual Pack	E80400-0509		E16400-0509		E32400-0509	
1+2+6+7+8	Female Housing with Contact Holder ****Lower Pilot Aux Holder, Cable Clamp w/ screws- (Red Key)- Individual Pack	E80500-0509		E16500-0509		E32500-0509	

*Lower pilot auxiliary contacts use the same housing location as air tubes so they can not be used together

**Universal yellow coding key is only used on male connectors

***EBC 160 and EBC 320 handles work with both the EBC 160 and EBC 320 series connectors

****No lower pilot auxiliary holder required on EBC 80 size connectors

PART NUMBER CONFIGURATOR

EBC 80 Connector Part Number Selection

Series	Gender	Main Contact	Handle	Coding Key	Auxiliary Contacts & Air Tubes	Packing
E80	4 or 5	25 -	1	0	2	9
4	Male					9 Individual
5	Female					8 Bulk
00	None - Order Separately				0	None
10	10 mm ² (8 AWG)				1	(2) Lower Pilot Auxiliary Contacts
16	16 mm ² (6 AWG)				2	(2) Upper Auxiliary Contacts
25	25 mm ² (4 AWG)				4	(2) Lower Pilot Auxiliary Contacts & (2) Upper Auxiliary Contacts
35	35 mm ² (2 AWG)				4	(2) Lower Pilot Auxiliary Contacts & (2) Upper Auxiliary Contacts
0	No			0	Grey, Wet Cell	5 Air Tube
1	Black			2	Green, Dry Cell	6 Air Tube & (2) Upper Auxiliary Contacts
2	Red			3	Yellow, Universal (use with male housing only)	
				4	Blue, Type II Dry Cell, High Power Coding Pin	
				5	*Red, Type II Wet Cell, High Power Coding Pin	

EBC 160 Connector Part Number Selection

Series	Gender	Main Contact	Handle	Coding Key	Auxiliary Contacts & Air Tubes	Packing
E16	4 or 5	25 -	1	0	2	9
4	Male					9 Individual
5	Female					8 Bulk
00	None - Order Separately				0	None
16	16 mm ² (6 AWG)				1	(2) Lower Pilot Auxiliary Contacts
25	25 mm ² (4 AWG)				2	(2) Upper Auxiliary Contacts
35	35 mm ² (2 AWG)				4	(2) Lower Pilot Auxiliary Contacts & (2) Upper Auxiliary Contacts
50	50 mm ² (1/0 AWG to 1 AWG)				4	(2) Lower Pilot Auxiliary Contacts & (2) Upper Auxiliary Contacts
0	No			0	Grey, Wet Cell	5 Air Tube
1	Black			2	Green, Dry Cell	6 Air Tube & (2) Upper Auxiliary Contacts
				3	Yellow, Universal (use with male housing only)	
				4	Blue, Type II Dry Cell, High Power Coding Pin	
				5	*Red, Type II Wet Cell, High Power Coding Pin	

EBC 320 Connector Part Number Selection

Series	Gender	Main Contact	Handle	Coding Key	Auxiliary Contacts & Air Tubes	Packing
E32	4 or 5	50 -	1	0	2	9
4	Male					9 Individual
5	Female					8 Bulk
00	None - Order Separately				0	None
50	50 mm ² (1/0 AWG to 1 AWG)				1	(2) Lower Pilot Auxiliary Contacts
70	70 mm ² (2/0 AWG to 3/0 AWG)				2	(2) Upper Auxiliary Contacts
95	95 mm ² (3/0 AWG to 4/0 AWG)				4	(2) Lower Pilot Auxiliary Contacts & (2) Upper Auxiliary Contacts
0	No					
1	Black			0	Grey, Wet Cell	5 Air Tube
				2	Green, Dry Cell	6 Air Tube & (2) Upper Auxiliary Contacts
				3	Yellow, Universal (use with male housing only)	
				4	Blue, Type II Dry Cell, High Power Coding Pin	
				5	*Red, Type II Wet Cell, High Power Coding Pin	

*Not available at this time, contact factory.

Packaging: Individual (Kits) - all components for a complete connector are packaged together in individual bags within one box Bulk (Kits) - all components required are packaged separately by part number selected in one bag/box.

Handles: EBC 80 comes with the low profile T handle • EBC 160 come with the low profile handle • EBC 320 come with the high profile handle.

DRAWINGS

Housing Dimensions							
		EBC 80		EBC 160		EBC 320	
		mm	in	mm	in	mm	in
Male Housings	A	68.0	2.68	83.5	3.29	89.5	3.52
	B	74.4	2.93	103.8	4.09	123.5	4.86
	C	26.1	1.03	33.4	1.31	40.8	1.61
Female Housings	A	68.0	2.68	83.5	3.29	89.5	3.52
	B	73.8	2.91	104.0	4.09	117.0	4.61
	C	26.1	1.03	32.6	1.28	37.6	1.48

Male Front View

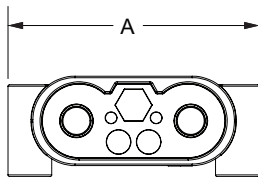

Male Top View

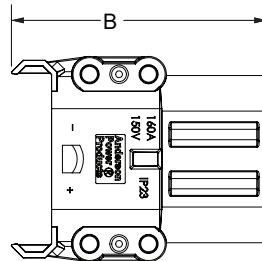

Male Side View

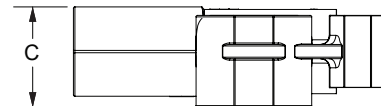

Female Front View

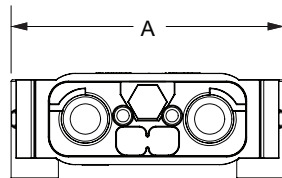

Female Top View

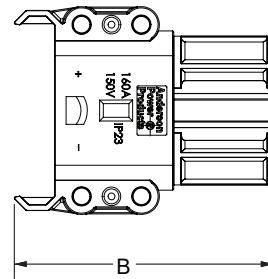

Female Side View

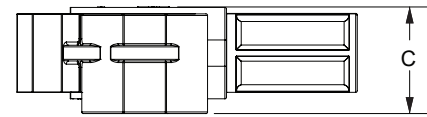

Dimensions of Housings With Handles

		EBC 80	
		mm	in
Male Housings	D	68.0	2.68
	E	41.2	1.62
	F	110.6	4.35
Female Housings	D	70.0	2.76
	E	41.2	1.62
	F	110.6	4.35

EBC 80 Male Housing with Handle

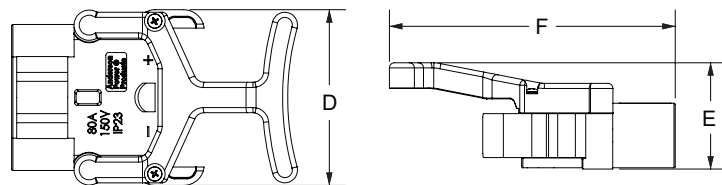

EBC 80 Female Housing with Handle

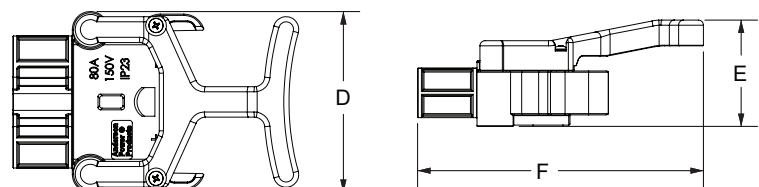

EBC 160 Handles

		Low Profile		High Profile				Low Profile		High Profile	
		mm	in	mm	in			mm	in	mm	in
Male Housings	D	101	4.0	106	4.2	Female Housings	D	101	4.0	106	4.2
	E	46	1.8	64	2.5		E	46	1.8	64	2.5
	F	168	6.6	167	6.6		F	173	6.8	172	6.8

**Male Housing
Low Profile Handle**

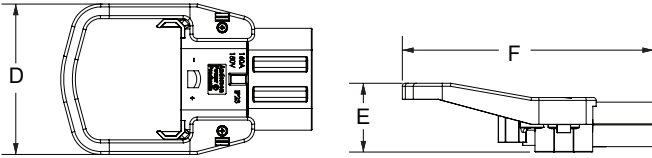

**Male Housing
High Profile Handle**

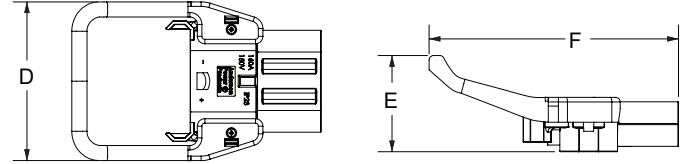

**Female Housing
Low Profile Handle**

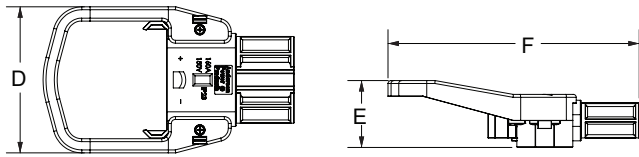

**Female Housing
High Profile Handle**

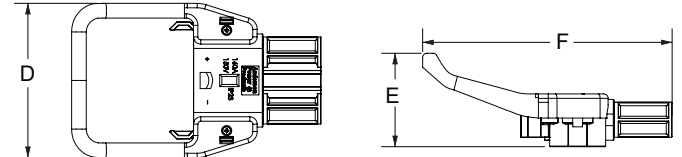

EBC 320 Handles

		Low Profile		High Profile				Low Profile		High Profile	
		mm	in	mm	in			mm	in	mm	in
Male Housings	D	101	4.0	106	4.2	Female Housings	D	101	4.0	106	4.2
	E	54	2.1	72	2.8		E	53	2.1	71	2.8
	F	175	6.9	174	6.9		F	171	6.7	173	6.8

**Male Housing
Low Profile Handle**

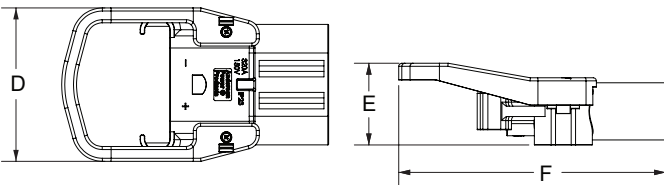

**Male Housing
High Profile Handle**

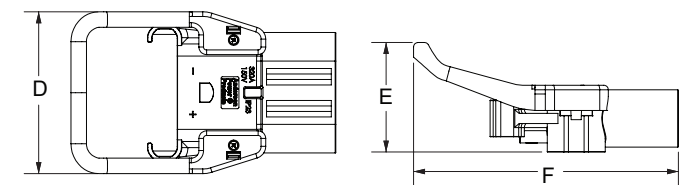

**Female Housing
Low Profile Handle**

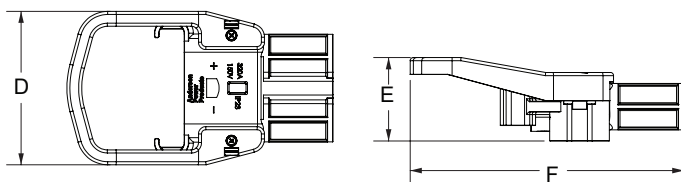

**Female Housing
High Profile Handle**

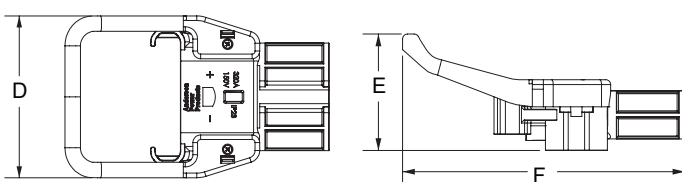

Latch Plate 160 & 320
P/N: A320LP-MK

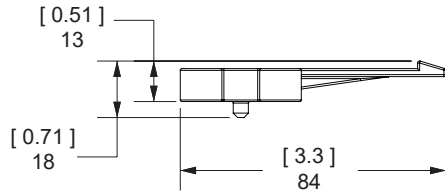
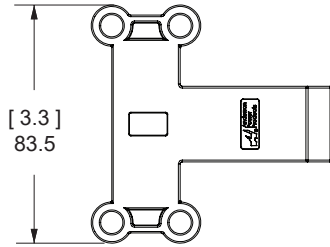

Latch Plate on
EBC 160 & 320 Male Housing

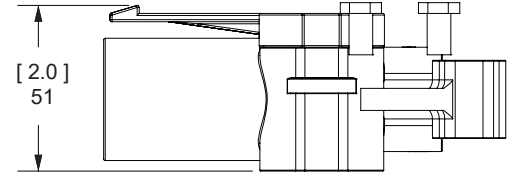

Handle & Lever Assembly
on EBC 160 & 320 Female Housing:
P/N: A320HL-MK

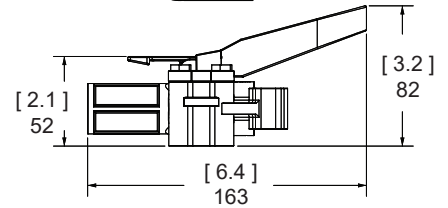
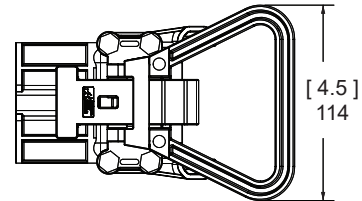

MANUAL RELEASE FOR EBC 160 & 320

P/N: 994G4

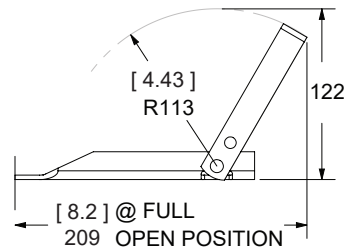
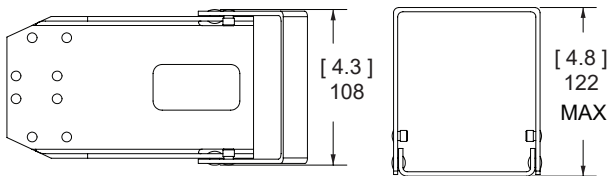

Battery Bracket
P/N: 993G4

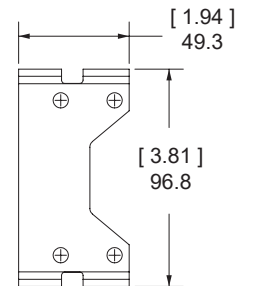

Manual Release with Connectors

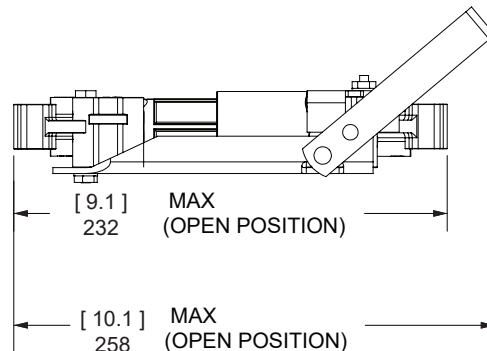
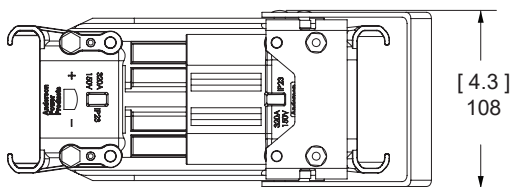

DOUBLE STACK for E160 & 320

Charger Truck Side

Part Number 994G6

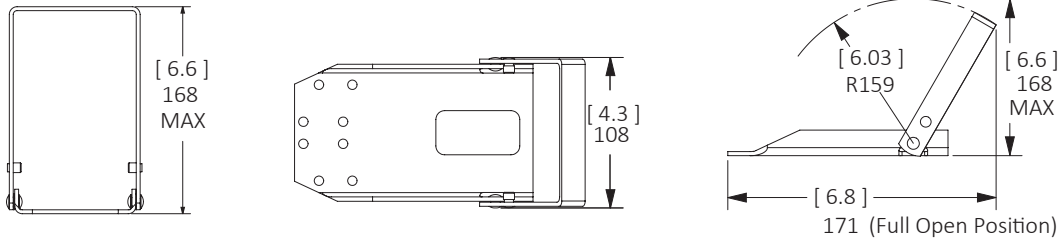

Battery Bracket

Part Number 993G6

Double Stack with Connectors

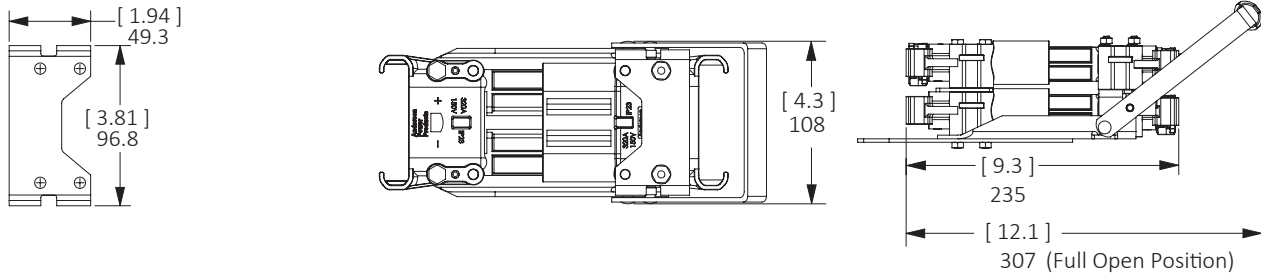

Manual Release and Double Stack Bracket

Part Number	Description
993G4	Manual Release Battery Bracket
993G6	Din 320 (A/E) Double Stack Battery Bracket Series
994G4	Manual Release for A160 & 320
994G6	Din 320 (A/E) Double Stack Truck Charger Bracket Series

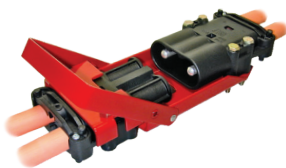

Manual Release

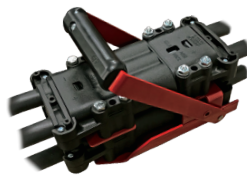

Double Stack

Contacts						
Series	Wire Size		OD		ID	
	Metric	AWG	mm	in	mm	in
EBC 80	10 mm ²	6 to 8	6.0	0.24	4.5	0.18
EBC 80 / 160	16 mm ²	4 to 6	8.4	0.33	6.0	0.24
	25 mm ²	2 to 4	11.0	0.43	8.0	0.31
EBC 160 / 320	35 mm ²	1 to 2	12.5	0.49	9.0	0.35
	50 mm ²	1 to 1/0	14.5	0.57	11.0	0.43
EBC 320	70 mm ²	2/0 to 3/0	17.0	0.67	13.0	0.51
	95 mm ²	3/0 to 4/0	19.8	0.78	15.0	0.59



Male Power Contact

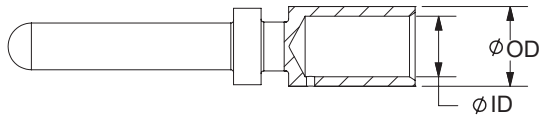

Female Power Contact

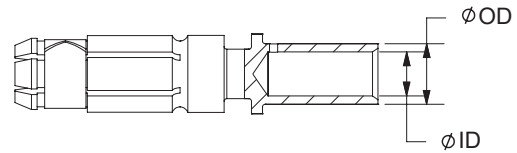

Upper Auxiliaries							Lower Pilot Auxiliaries					
Series	Wire Size		OD		ID		Wire Size		OD		ID	
	mm ²	AWG	mm	in	mm	in	mm ²	AWG	mm	in	mm	in
EBC 80	2.5	14 to 18	3.9	0.15	2.2	0.09	2.5	14 to 18	3.9	0.15	2.2	0.09
EBC 160 / 320	4	12	4.1	0.16	2.9	0.11	6.0	10	5.0	0.20	3.9	0.15

Upper Auxiliary Pin

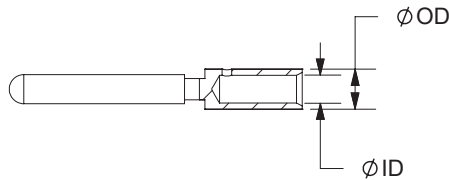

Upper Auxiliary Socket

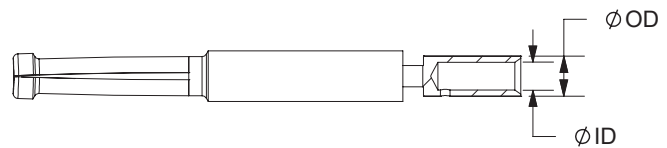

Lower Pilot Auxiliary Pin

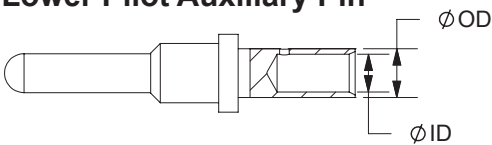

Lower Pilot Auxiliary Socket

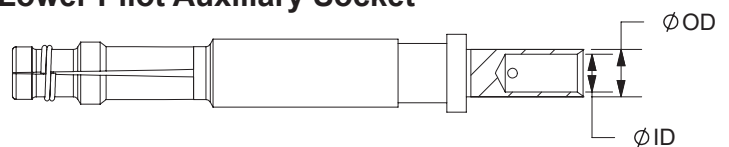

Female Twin Air Tube							Male Twin Air Tube					
Series	G		H		J		G		H		J	
	mm	in	mm	in	mm	in	mm	in	mm	in	mm	in
EBC 80	102	4.0	15.8	0.62	13.0	0.51	87	3.4	15.8	0.62	13.0	0.51
EBC 160 / 320	154	6.1	17.8	0.70	13.9	0.55	125	4.9	17.8	0.70	14.0	0.55

Female Air Tube

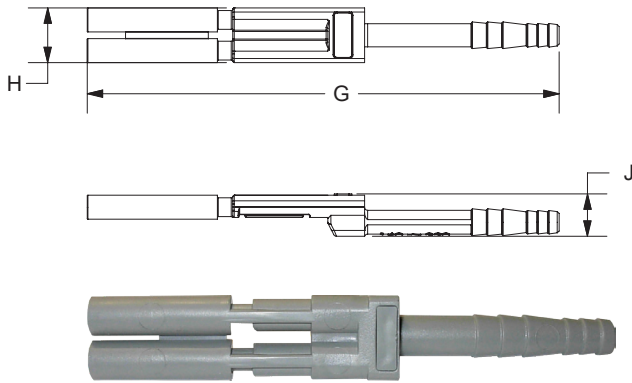

Male Air Tube

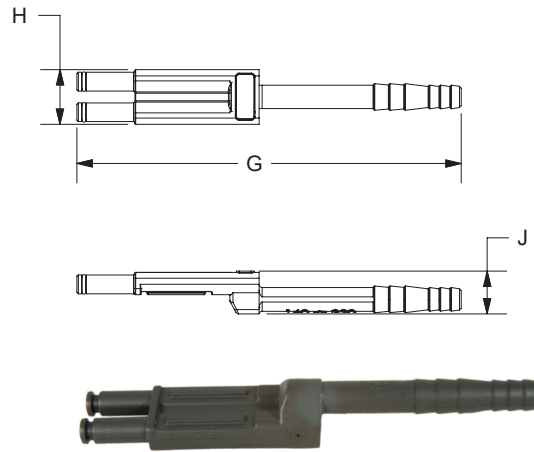

Wet / Dry Voltage Key				Universal Voltage Key				
Series	K		L		K		L	
	mm	in	mm	in	mm	in	mm	in
EBC 80	8.0	0.31	45	1.77	8.0	0.31	46	1.8
EBC 160 / 320	9.3	0.37	69	2.72	11.8	0.46	69	2.7

Wet / Dry Voltage Key - Grey or Green

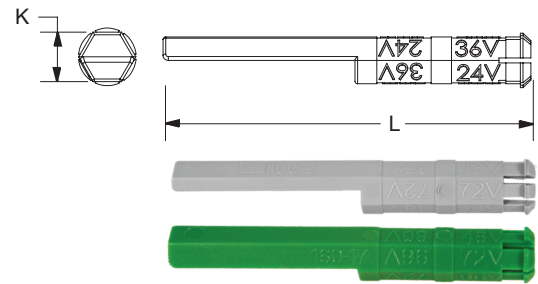

Keying Plug	Identification	Assembled In
	Used for Wet Cell Battery /Charger - Color Grey	Battery Receptacle and Charging Plug
	Used for Dry Cell Battery/Charger - Color Green	Battery Receptacle and Charging Plug
	Used for Vehicle only - Yellow (Universal)	Vehicle Plug only- used when vehicle may use wet or dry cell batteries.
	Used for Type II Dry Cell Battery/Charger - Color Blue	Battery Receptacle and Charging Plug
	Used for Type II Wet Cell Battery/Charger - Color Red* *Not available, contact factory	Battery Receptacle and Charging Plug

Universal Voltage Key - Yellow

(use with male housing only)

Universal (Yellow) voltage keys are to be used exclusively at the vehicle side to permit both the use of wet-cell and dry-cell batteries.

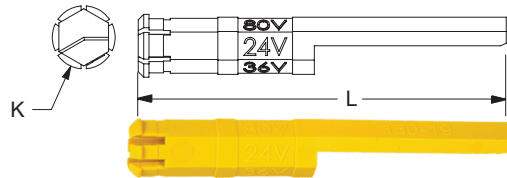

Type II Dry Cell Battery/Charger Key - Blue

(Male & Female)



Type II Wet Cell Battery/Charger Key - Red

(Male & Female)



TOOLING INFORMATION

EBC Series, E160, & E320 - Hydraulic Tooling

Wire Size		Part Numbers		Loose Piece Contact Crimp Tools				
mm ²	AWG	Power Contact	Hydraulic Hand Bench Tool	+	Die	or	Hydraulic Hand Bench Tool	
10 mm ²	8 to 6	80-1010	1387G3 or Cembre B500A ¹		1322G16		N/A	
		80-1110						
N/A	6	80-1016			1322G9			
		80-1116						
16 mm ²	N/A	80-1016			1322G10			
		80-1116						
25 mm ²	4 to 2	80-1025			1322G12			
		80-1125						
35 mm ²	2 to 1	80-1035			N/A			1322G15
		80-1135						
16 mm ²	6 to 4	160-1016	1387G3 or Cembre B500A ¹		1322G9		1368 Series	
		160-1116						
25 mm ²	4 to 2	160-1025			1322G12			
		160-1125						
35 mm ²	2 to 1	160-1035			1322G7			
		160-1135						
50 mm ²	1 to 1/0	160-1050			1322G4			
		160-1150						
		320-1050						
		320-1150						
70 mm ²	2/0 to 3/0	320-1070	1322G3 (K) *	1322G2				
		320-1170						
95 mm ²	3/0 to 4/0	320-1095	1322G1					
		320-1195						
Pilot/Auxiliary Contacts								
All	Pins		Solder Only					
	Sockets							

* Use 1322G3 with K stranded wire only.

¹ www.cembreinc.com



1387G3 or Cembre B500A ¹



1368



1368-NL

EBC Series E80, E160, & E320 - Pneumatic Tooling

Wire Size		Part Numbers		Loose Piece Contact Crimp Tools			
mm ²	AWG	Power Contact	Pneumatic Bench Tool	+	Die	+	Locator (Single Crimp)
10 mm ²	8 to 6	80-1010	1387G2		13003G20		1304G34
		80-1110					
16 mm ²	6 to 4	80-1016					
		80-1116					
25 mm ²	4 to 2	80-1025	N/A		N/A		N/A
		80-1125					
35 mm ²	2 to 1	80-1035					
		80-1135					
mm ²	AWG	Power Contact	Pneumatic Bench Tool	+	Die	+	Locator (Double Crimp)
16 mm ²	6 to 4	160-1016	1387G2		1303G14		1304G21 Sockets 1304G20 Pins
		160-1116					
25 mm ²	4 to 2	160-1025					
		160-1125					
35 mm ²	2 to 1	160-1035					
		160-1135					
50 mm ²	1 to 1/0	160-1050					
		160-1150					
		320-1050					
		320-1150					
70 mm ²	2/0 AWG	320-1070					
		320-1170					
95 mm ²	3/0 AWG	320-1095					
	4/0 AWG	320-1195					
Pilot/Auxiliary Contacts							
All		All Crimp Pins	Solder Only				
		All Crimp Sockets					



1368-B



1387G1 & 1387G2

EURO-BATTERIESTECKER

Die Euro-Batteriestecker (Euro Battery Connectors, EBC) der Anderson™-Familie wurden fachkundig mit dem Ziel der einfachen Bedienbarkeit konzipiert und weisen einen innovativen Kontaktträger auf, der die Montage vereinfacht. Die EBC-Stecker liegen in den industriellen Standardgrößen 80, 160 und 320 vor, die alle der Norm VDE 0623-589 entsprechen. Design und Materialien bieten Leistungsmerkmale, die alle Anforderungen der Norm EN1175:2020 erfüllen oder übertreffen. Alle ausgewählten Materialien sind RoHS-konform und wurden so ausgewählt, dass jahrelange Zuverlässigkeit in schwierigen Industrieumgebungen gewährleistet wird. Dank dieser Attribute sind die EBC-DIN-Stecker die richtige Wahl für eine breite Palette an industriellen Einsatzmöglichkeiten bei Materialhandhabung, Batterieaufladung, Nutzfahrzeugen, Antriebstechnik, Kehrmaschinen und vielen weiteren Anwendungen.



HAUPTMERKMALE

Sicherheitszertifizierungen

EN1175:2020  File No. E26226

Erfüllt VDE 0623-589, völlig kompatibel mit DIN 43589-1

Bietet Schnittstellenkompatibilität für die Gehäuse, die Kontakte und die Luftadapter.

Spannungscodierstifte

EBC-Stecker bieten Codierstifte für Trockenzellen-, Nasszellen und universelle Anwendungen, die für DC-Anwendungen mit 24/36/48/72/80 und 96 Volt codiert sind.

Stabile, moderne Polymer-Gehäuse

Bieten überragenden Widerstand bei Schlag-, Säure- und Temperaturbelastungen.

Versilberte Kupferkontakte

Bieten hervorragende Leitfähigkeit und überragende Steckzyklen.



SPEZIFIKATIONEN

Elektrische Werte

Stromstärke (Ampere)

Kabelquerschnitt:	EN1175	E80		E160			E320		
		CNR	USR	EN1175	CNR	USR	EN1175	CNR	USR
10 mm ²	N/V	70	90	N/V	N/V	N/V	N/V	N/V	N/V
16 mm ²	80	90	120	80	90	120	N/V	N/V	N/V
25 mm ²	120	110	140	120	120	160	N/V	N/V	N/V
35 mm ²	160	120	160	160	140	180	N/V	N/V	N/V
50 mm ²	N/V	N/V	N/V	250	160	220	250	165	220
75 mm ²	N/V	N/V	N/V	N/V	N/V	N/V	N/V	200	260
95 mm ²	N/V	N/V	N/V	N/V	N/V	N/V	400	260	340

HINWEIS: Alle Hilfskontakte, unabhängig von der Drahtgröße, sind für mindestens 20 A ausgelegt, wenn sie gemäß EN1175:2020 Prüfanforderungen verwendet werden

- EN1175:2020-Ermöglicht einen maximalen Temperaturanstieg = 65 °C (über 25 ± 5 °C Umgebungstemperatur)
- CNR- Ermöglicht einen maximalen Temperaturanstieg =30°C
- USR- Ermöglicht eine Gesamttemperatur (basierend auf einer Umgebungstemperatur von mindestens 25 °C) = 75 °C

Betriebsspannung

	EBC 80			EBC 160			EBC 320		
	EN1175	CNR	USR	EN1175	CNR	USR	EN1175	CNR	USR
AC / DC	150V	600V	600V	150V	600V	600V	150V	600V	600V
DWV (AC)	2000	2200	2200	2000	2200	2200	2000	2200	2200

Kabelbereich

	EBC 80		EBC 160		EBC 320	
	mm ²	AWG	mm ²	AWG	mm ²	AWG
Strom – Min.	10	8	16	6	50	1/0
Strom – Max.	35	2	50	1/0	95	4/0
Oberer Hilfs.- Min.	1.5	18	4	12	4	12
Oberer Hilfs.- Max.	2.5	14	4	12	4	12
Unterer Führungs-/Hilfs.- Min.	1.5	18	6	10	6	10
Unterer Führungs-/Hilfs.- Max.	2.5	14	6	10	6	10

Durchschnittlicher Anfangskontaktwiderstand in zusammengefügttem Steckeranschluss – Mikroohm

	EBC 80	EBC 160	EBC 320
Durchschn. Kontaktwiderstand – Strom	176	95	77
Durchschn. Kontaktwiderstand – Hilfs.	1100	920	1000

Betriebstemperatur (alle Serien): -20 bis 105 °C

Mechanische Werte

Lebenszyklus - Für EN1175:2020

	EBC 80	EBC 160	EBC 320
Keine Belastung	>5000	>5000	>5000
Unter Belastung (Hot-Plugging bei 96 V)	5 bei 400 A	5 bei 625 A	5 bei 1000 A
Versch. Daten	EBC 80	EBC 160	EBC 320
Durchschn. Steckkraft N (lb)	68 (15,3)	170 (38,2)	71 (16,0)
Kontakthaltung N (lb)	134 (30) min	445 (100) min	445 (100) min
Schutzgrad	IP23	IP23	IP23
Säurebeständigkeit gemäß EN1175:2020	Bestanden	Bestanden	Bestanden
Max. Druckbelastung in Bar (PSI) Luftadapter	0,8 (11,6)	0,8 (11,6)	0,8 (11,6)
Entflammbarkeit	UL94 V0		

Materialien

EBC 80 - EBC 160 - EBC 320

Gehäuse	PBT/PC-Blend
Kontakte	Kupferlegierung
Kontaktbeschichtung – Strom (min.)	Versilbert – 6 Micron
Kontaktbeschichtung – Hilfs. (min.)	Versilbert – 6 Micron
Hardware	Stahl, Zinkchromat

TEMPERATURTABELLEN

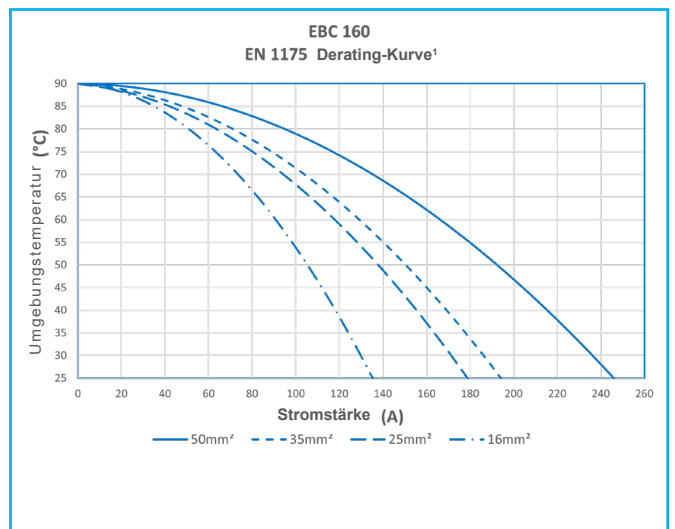
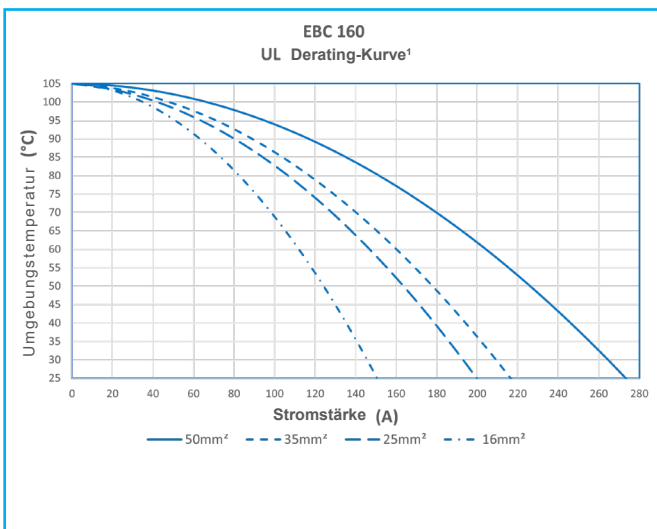
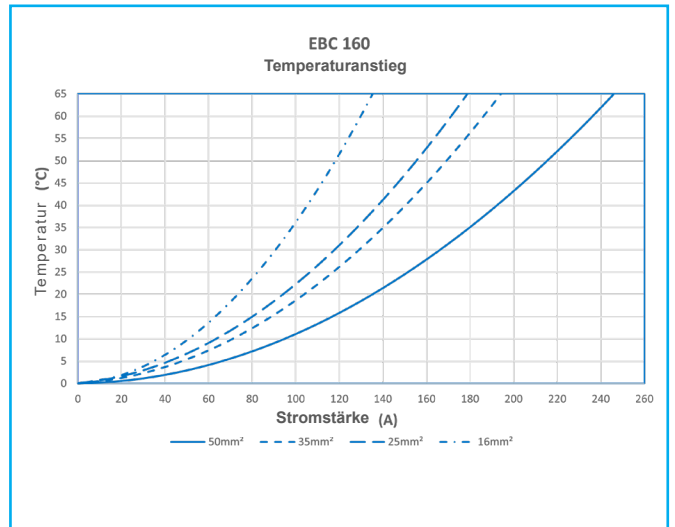
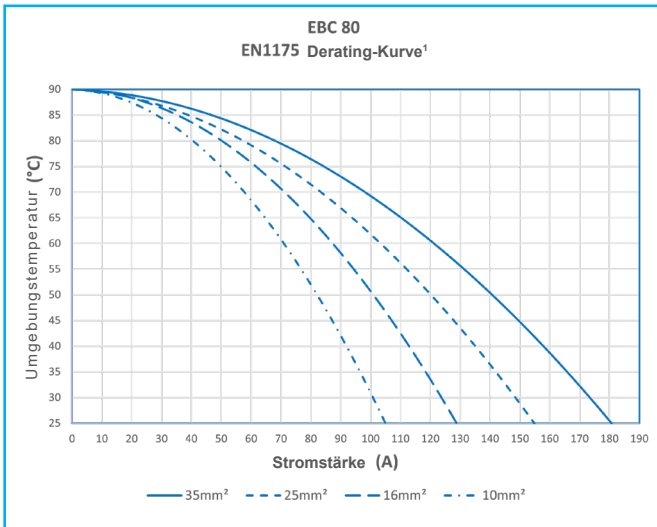
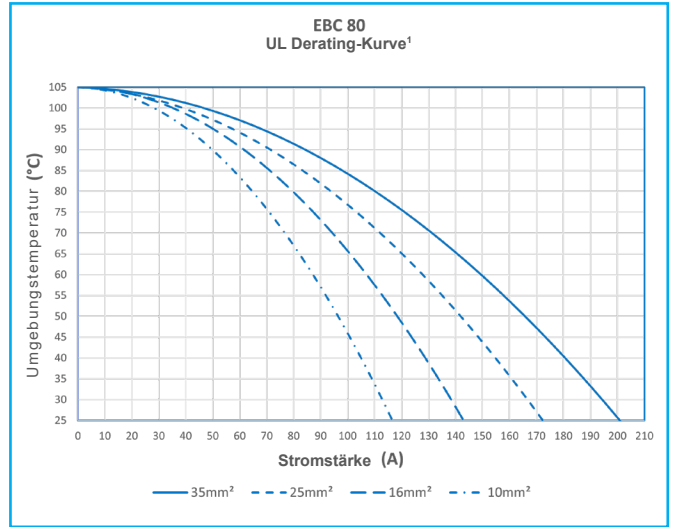
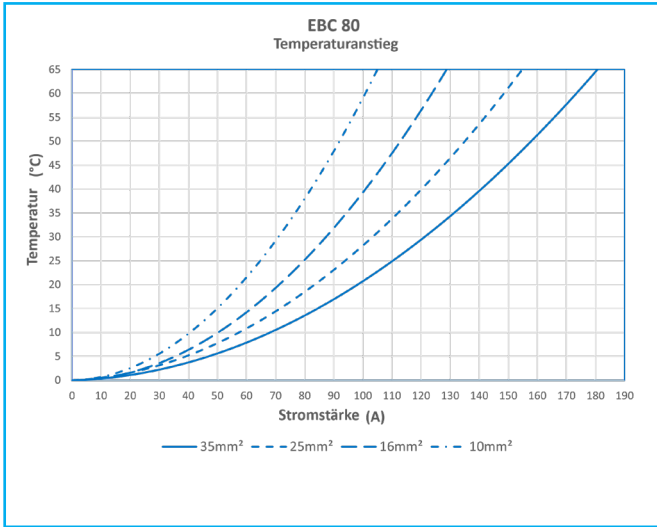

¹ 0,8 Derating pro IEC 60512-3

HINWEIS 1: Temperaturwerte basieren nur auf Kontakten mit eingeschalteter Spannungsversorgung.

HINWEIS 2: Temperaturanstiegsdiagramme basieren auf einer Umgebungstemperatur von 25 °C.

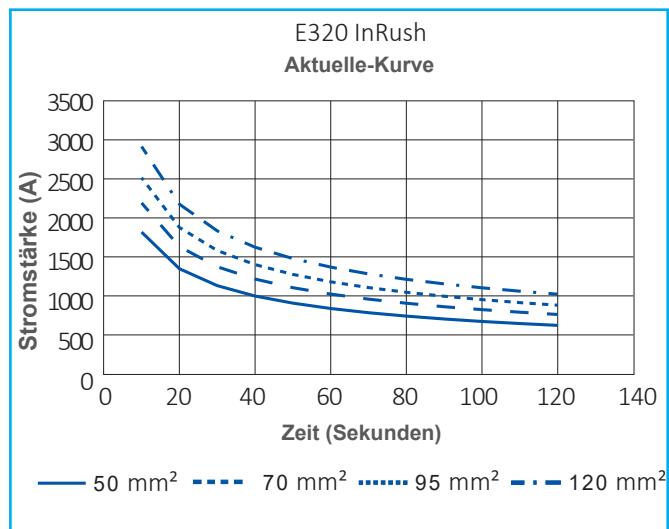
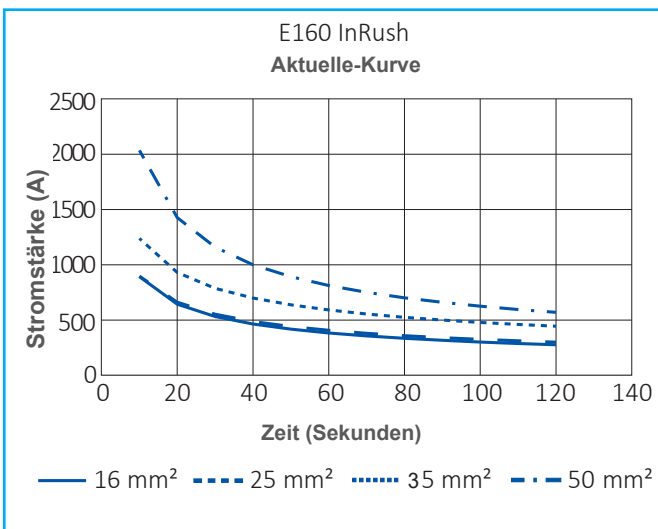
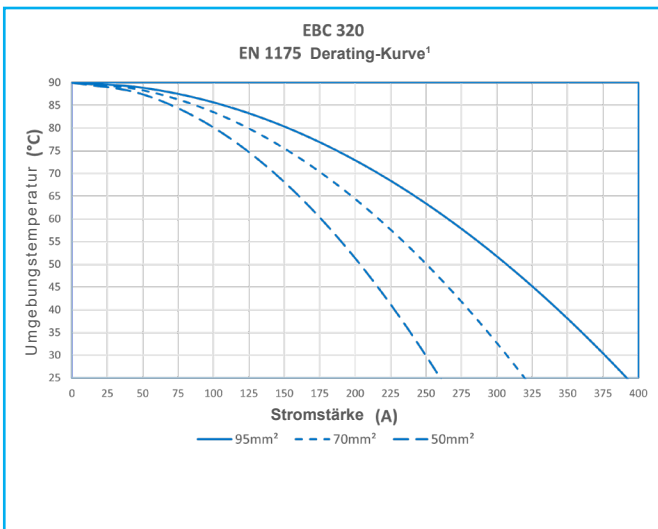
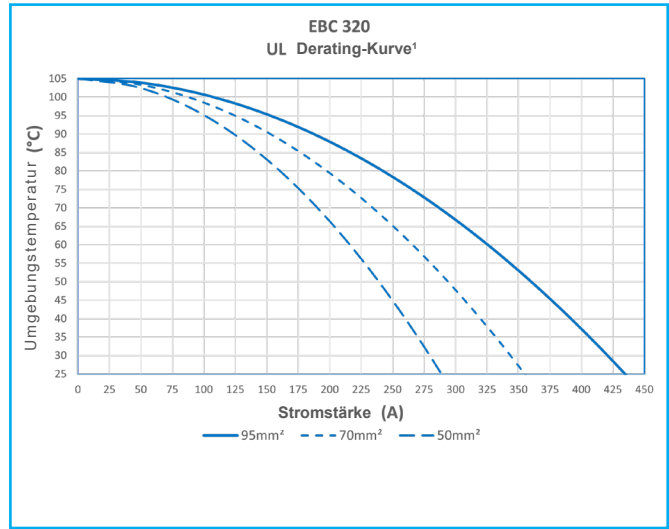
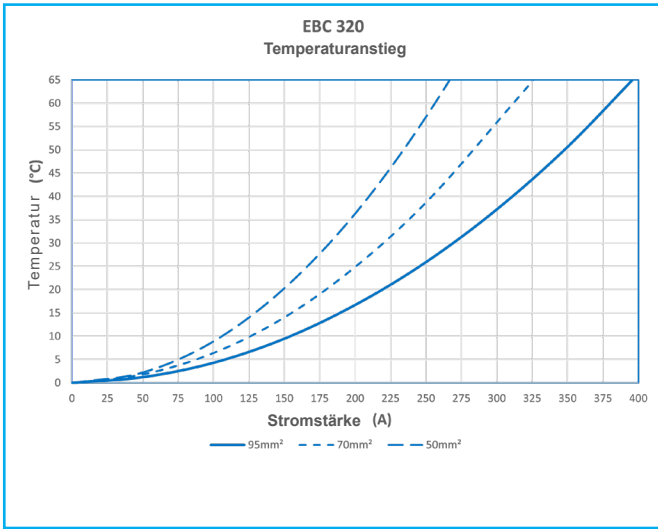

BESTELLINFORMATIONEN

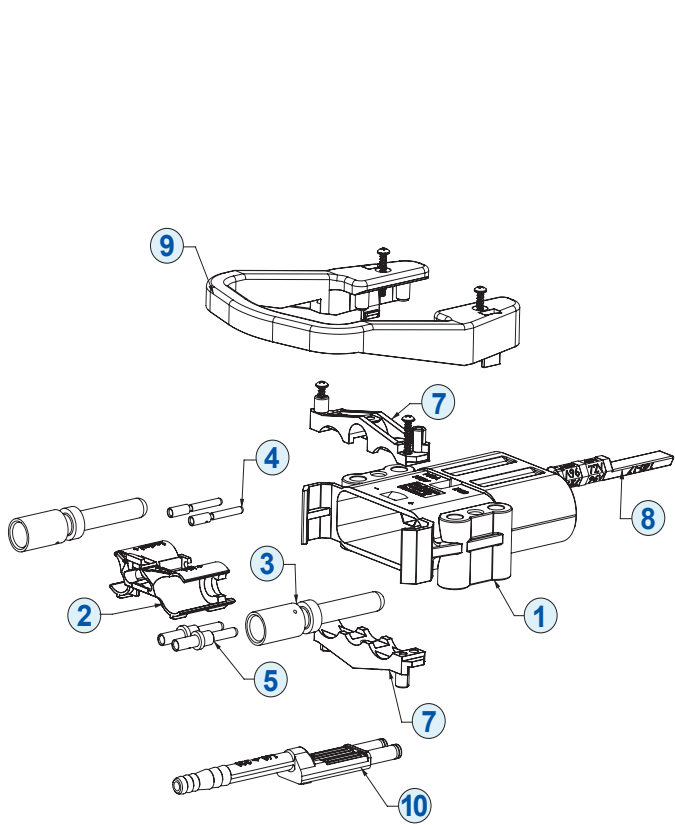

Stecker

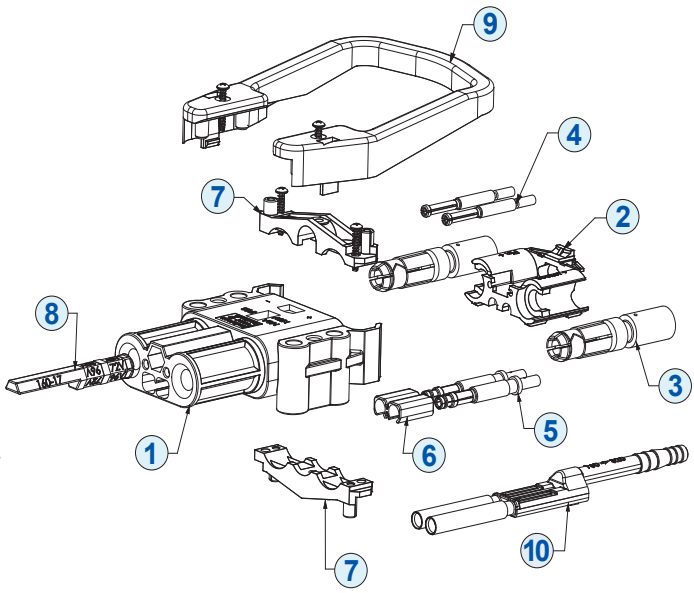

Steckerbuchse

Komponenten

Teilenummer	Beschreibung	EBC 80		EBC 160		EBC 320	
		Stecker	Buchse	Stecker	Buchse	Stecker	Buchse
3	Stromkontakte						
	10 mm ² (8 AWG)	80-1010	80-1110	N/V	N/V	N/V	N/V
	16 mm ² (6AWG)	80-1016	80-1116	160-1016	160-1116	N/V	N/V
	25 mm ² (4 AWG)	80-1025	80-1125	160-1025	160-1125	N/V	N/V
	35 mm ² (2 AWG)	80-1035	80-1135	160-1035	160-1135	N/V	N/V
	50 mm ² (1 AWG to 1/0)	N/V	N/V	160-1050	160-1150	320-1050	320-1150
	70 mm ² (2/0 to 3/0)	N/V	N/V	N/V	N/V	320-1070	320-1170
	95 mm ² (3/0 to 4/0)	N/V	N/V	N/V	N/V	320-1095	320-1195
4	Oberer Hilfskontakt	E80-32	E80-33	E160-32	E160-33	E320-34	E320-35
5	* Unterer Führungs-/Hilfskontakt	E80-30	E80-31	160-12	160-13	160-12	160-13
8	Spannungscodierstifte						
	c – Nasszelle (160 und 320 verwenden dieselben Codierstifte)	80-9	80-9	160-9	160-9	160-9	160-9
	Grüner Codierstift – Trockenzelle (160 und 320 verwenden dieselben Codierstifte)	80-17	80-17	160-17	160-17	160-17	160-17
	** Gelber Codierstift (160 und 320 verwenden dieselben Codierstifte)	80-19	N/V	160-19	N/V	160-19	N/V
	Blauer Codierstift, Typ II trocken (160 und 320) verwenden Sie die gleichen Codierstifte)	80-22M	80-22F	160-22M	160-22F	160-22M	160-22F
	Roter Codierstift, Typ II nass (160 und 320 verwenden die gleichen Codierstifte) – Wenden Sie sich an das Werk	80-23M	80-23F	160-23M	160-23F	160-23M	160-23F
9	*** Griff – hohes Profil m/Schrauben	N/V	N/V	E320-89	E320-89	E320-89	E320-89
	***Griff – flaches Profil m/Schrauben	E80-89	E80-89	E160-89	E160-89	E160-89	E160-89
	Roter Griff – flaches Profil m/Schrauben	80-8-R	80-8-R	N/V	N/V	N/V	N/V
10	* Luftadapter	E80-20	E80-21	E160-20	E160-21	E320-20	E320-21
1	Nur Gehäuse	EP80-1	EP80-2	EP160-1	EP160-2	EP320-1	EP320-2
2	Kontakthalter	80-5B	80-5B	EP160-5	EP160-5	EP320-5	EP320-5
6	Zusätzlicher unterer Führungs-/Hilfsalter	N/V	N/V	N/V	EP320-38	N/V	EP320-38
7	Kabelklemmen mit Schrauben	EP80-67	EP80-67	EP160-67	EP160-67	EP320-67	EP320-67
1+2+7+8	Steckergehäuse mit Kontakthalter und Kabelklemme mit Schrauben (grauer Codierstift) – Einzelpackung	E80400-0009		E16400-0009		E32400-0009	
1+2+6+7+8	Buchsengehäuse mit Kontakthalter, **** unterer Führungs-/Hilfsalter, Kabelklemmen mit Schrauben – (grauer Codierstift) – Einzelpackung	E80500-0009		E16500-0009			
1+2+7+8	Steckergehäuse mit Kontakthalter und Kabelklemme mit Schrauben (grüner Codierstift) – Einzelpackung	E80400-0209		E16400-0209		E32400-0209	
1+2+6+7+8	Buchsengehäuse mit Kontakthalter, **** unterer Führungs-/Hilfsalter, Kabelklemmen mit Schrauben – (grüner Codierstift) – Einzelpackung	E80500-0209		E16500-0209		E32500-0209	
1+2+7+8	Steckergehäuse mit Kontakthalter und Kabelklemme mit Schrauben (gelber Codierstift) – Einzelpackung	E80400-0309		E16403-0309		E32400-0309	
1+2+7+8	Steckergehäuse mit Kontakthalter und Kabelklemme mit Schrauben (blau Codierstift) – Einzelpackung	E80400-0409		E16400-0409		E16400-0409	
1+2+6+7+8	Buchsengehäuse mit Kontakthalter ****Unterer Pilot-Aux-Halter, Kabelklemme mit Schrauben (blau Codierstift) – Einzelverpackung	E80500-0409		E16400-0409		E32500-0409	
1+2+7+8	Steckergehäuse mit Kontakthalter und Kabelklemme mit Schrauben (roter Codierstift) – Einzelpackung	E80400-0509		E16400-0509		E32400-0509	
1+2+6+7+8	Buchsengehäuse mit Kontakthalter ****Unterer Pilot-Aux-Halter, Kabelklemme mit Schrauben (roter Codierstift) – Einzelverpackung	E80500-0509		E16500-0509		E32500-0509	

* Untere Führungs-/Hilfskontakte verwenden dieselbe Gehäuseposition wie Luftadapter. Daher können sie nicht zusammen verwendet werden.

** Der universelle gelbe Codierstift wird nur bei Steckeranschlüssen verwendet.

*** EBC 160- und EBC 320-Griffe können mit den Anschlüssen der EBC 160- und EBC 320-Serie verwendet werden.

- 22 - **** Für Anschlüsse der Größe EBC 80 sind keine Führungs-/Hilfsalter erforderlich

KONFIGURATION FÜR TEILENUMMERN

Auswahl der Teilenummer für EBC 80-Stecker

Serie	Geschlecht	Hauptkontakt	Griff	Codierstift	Hilfskontakte & Luftadapter	Verpackung
E80	4 oder 5	25	-	1	0	2 9
4	Stecker					9 Einzelpackung
5	Buchse					8 Großverpackung
00	Keine – Separat bestellen				0 Keine	
10	10 mm ² (8 AWG)				1 (2) Untere Führungs-/Hilfskontakte	
16	16 mm ² (6 AWG)				2 (2) Obere Hilfskontakte	
25	25 mm ² (4 AWG)				4 (2) Untere Führungs-/Hilfskontakte & (2) Obere Hilfskontakte	
35	35 mm ² (2 AWG)					
0	Nein			0 Grau, Nasszelle	5 Luftadapter	
1	Schwarz			2 Grün, Trockenzelle	6 Luftadapter & (2) Obere Hilfskontakte	
2	Rot			3 Gelb, universell (Verwendung nur mit Steckergehäuse)		
				4 Blau, Trockenzelle Typ II, Hochleistungs-Kodierstift		
				5 *Rot, Nasszelle Typ II, Hochleistungs-Kodierstift		

Auswahl der Teilenummer für EBC 160-Stecker

Serie	Geschlecht	Hauptkontakt	Griff	Codierstift	Hilfskontakte & Luftadapter	Verpackung
E16	4 oder 5	25	-	1	0	2 9
4	Stecker					9 Einzelpackung
5	Buchse					8 Großverpackung
00	Keine – Separat bestellen				0 Keine	
16	16 mm ² (6 AWG)				1 (2) Untere Führungs-/Hilfskontakte	
25	25 mm ² (4 AWG)				2 (2) Obere Hilfskontakte	
35	35 mm ² (2 AWG)				4 (2) Untere Führungs-/Hilfskontakte & (2) Obere Hilfskontakte	
50	50 mm ² (1/0 AWG bis 1 AWG)					
0	Nein			0 Grau, Nasszelle	5 Luftadapter	
1	Schwarz			2 Grün, Trockenzelle	6 Luftadapter & (2) Obere Hilfskontakte	
				3 Gelb, universell (Verwendung nur mit Steckergehäuse)		
				4 Blau, Trockenzelle Typ II, Hochleistungs-Kodierstift		
				5 *Rot, Nasszelle Typ II, Hochleistungs-Kodierstift		

Auswahl der Teilenummer für EBC 320-Stecker

Serie	Geschlecht	Hauptkontakt	Griff	Codierstift	Hilfskontakte & Luftadapter	Verpackung
E32	4 oder 5	50	-	1	0	2 9
4	Stecker					9 Einzelpackung
5	Buchse					8 Großverpackung
00	Keine – Separat bestellen				0 Keine	
50	50 mm ² (1/0 AWG bis 1 AWG)				1 (2) Untere Führungs-/Hilfskontakte	
70	70 mm ² (2/0 AWG bis 3/0 AWG)				2 (2) Obere Hilfskontakte	
95	95 mm ² (3/0 AWG bis 4/0 AWG)				4 (2) Untere Führungs-/Hilfskontakte & (2) Obere Hilfskontakte	
0	Nein			0 Grau, Nasszelle	5 Luftadapter	
1	Schwarz			2 Grün, Trockenzelle	6 Luftadapter & (2) Obere Hilfskontakte	
				3 Gelb, universell (Verwendung nur mit Steckergehäuse)		
				4 Blau, Trockenzelle Typ II, Hochleistungs-Kodierstift		
				5 *Rot, Nasszelle Typ II, Hochleistungs-Kodierstift		

*Diesmal nicht verfügbar, wenden Sie sich an das Werk.

Verpackung:

Einzelpackung (Kits) – alle Komponenten für einen vollständigen Anschluss werden zusammen in Einzelpackungen in einer Schachtel verpackt.
 Großverpackung (Kits) – alle erforderlichen Komponenten werden nach Teilenummer getrennt in einer Schachtel/Kiste verpackt.

Griffe:

EBC 80 wird mit dem flachen T-Griff geliefert • EBC 160 wird mit dem flachen Griff geliefert • EBC 320 wird mit dem hohen Griff geliefert.

ZEICHNUNGEN

		EBC 80		EBC 160		EBC 320	
		mm	Zoll	mm	Zoll	mm	Zoll
Stecker- gehäuse	A	68,0	2,68	83,5	3,29	89,5	3,52
	B	74,4	2,93	103,8	4,09	123,5	4,86
	C	26,1	1,03	33,4	1,31	40,8	1,61
Buchsen- gehäuse	A	68,0	2,68	83,5	3,29	89,5	3,52
	B	73,8	2,91	104,0	4,09	117,0	4,61
	C	26,1	1,03	32,6	1,28	37,6	1,48

Stecker-Vorderansicht

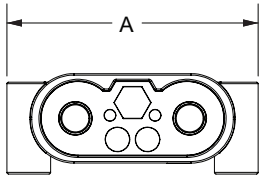

Stecker-Draufsicht

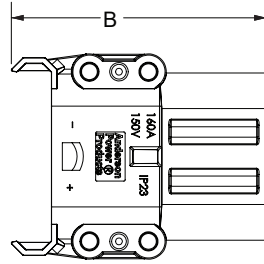

Stecker-Seitenansicht

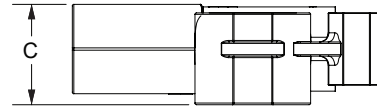

Gehäuse-Vorderansicht

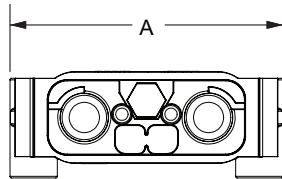

Gehäuse-Draufsicht

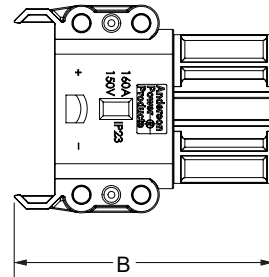

Gehäuse-Seitenansicht

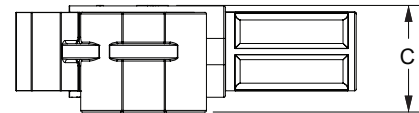

Abmessungen der Gehäuse mit Griffen

		EBC 80	
		mm	Zoll
Stecker- gehäuse	D	68,0	2,68
	E	41,2	1,62
	F	110,6	4,35
Buchsen- gehäuse	D	70,0	2,76
	E	41,2	1,62
	F	110,6	4,35

EBC 80 Steckergehäuse mit Griff

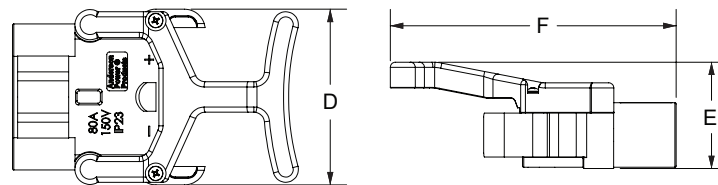

EBC 80 Buchsengehäuse mit Griff

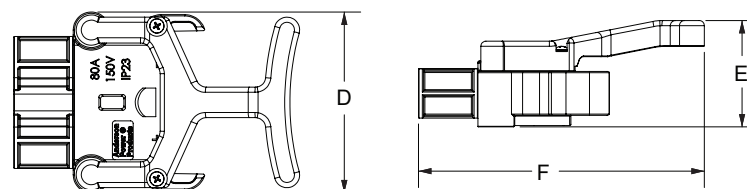

EBC 160-Griffe

		Flaches Profil		Hohes Profil				Flaches Profil		Hohes Profil	
		mm	Zoll	mm	Zoll			mm	Zoll	mm	Zoll
Steckergehäuse	D	101	4,0	106	4,2	Buchsengehäuse	D	101	4,0	106	4,2
	E	46	1,8	64	2,5		E	46	1,8	64	2,5
	F	168	6,6	167	6,6		F	173	6,6	172	6,8

Steckergehäuse, Griff mit flachem Profil

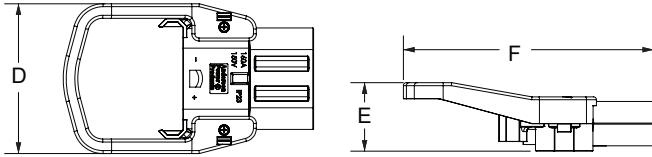

Steckergehäuse, Griff mit hohem Profil

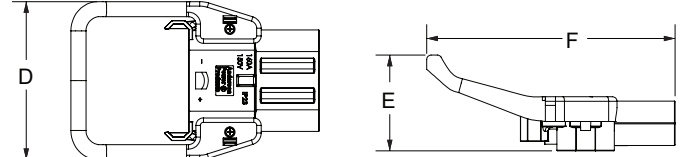

Buchsengehäuse, Griff mit flachem Profil

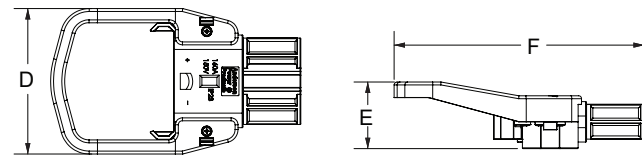

Buchsengehäuse, Griff mit hohem Profil

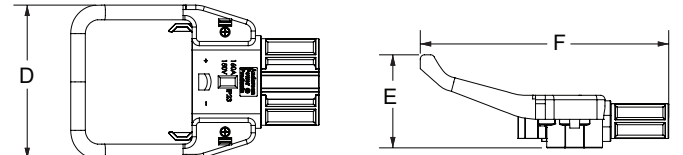

EBC 320-Griffe

		Flaches Profil		Hohes Profil				Flaches Profil		Hohes Profil	
		mm	Zoll	mm	Zoll			mm	Zoll	mm	Zoll
Steckergehäuse	D	101	4,0	106	4,2	Buchsengehäuse	D	101	4,0	106	4,2
	E	54	2,1	72	2,8		E	53	2,1	71	2,8
	F	175	6,9	174	6,9		F	171	6,7	173	6,8

Steckergehäuse, Griff mit flachem Profil

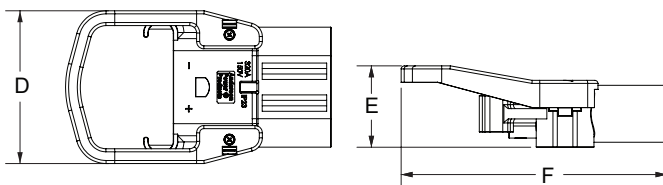

Steckergehäuse, Griff mit hohem Profil

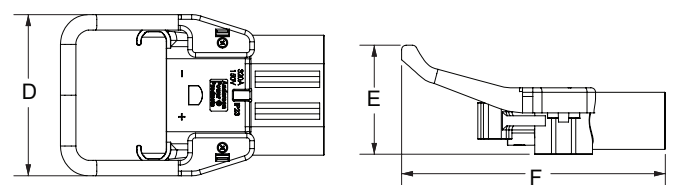

Buchsengehäuse, Griff mit flachem Profil

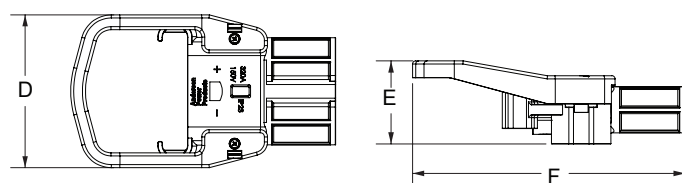

Buchsengehäuse, Griff mit hohem Profil

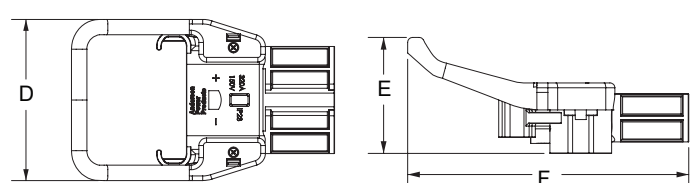

Steckzunge 160 & 320
Artikelnummer: A320LP-MK

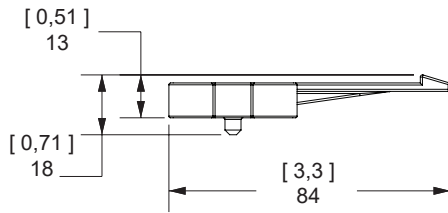
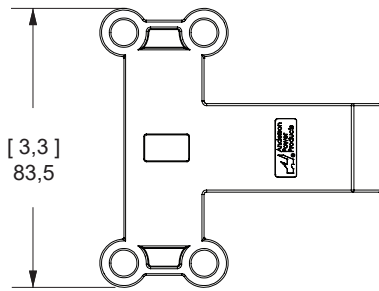

Steckzunge auf
EBC 160 & 320-Steckergehäuse

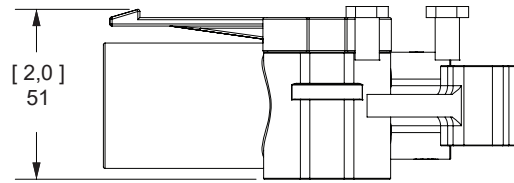

Griff- und Hebelmontage auf
Buchsengehäuse von EBC 160 & 320
Artikelnummer: A320HL-MK

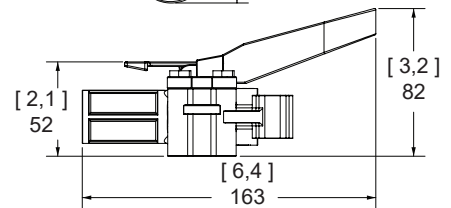
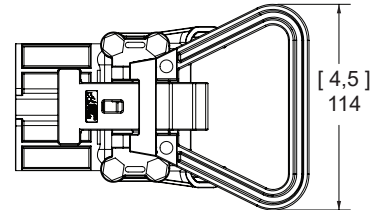

MANUELLE ENTRIEGELUNG FÜR E160 & 320

Artikelnummer: 994G4

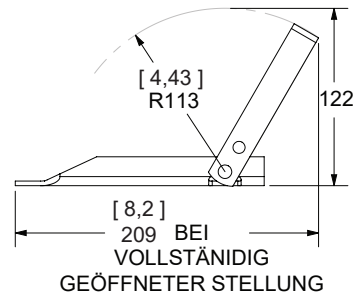
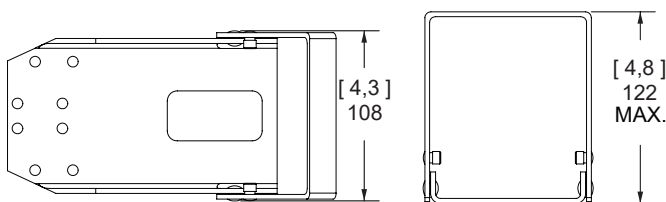

Batteriehalterung

Artikelnummer: 993G4

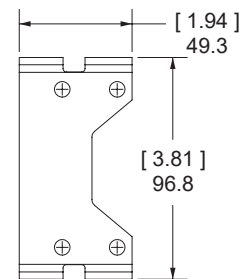

Manuelle Entriegelung mit Steckern

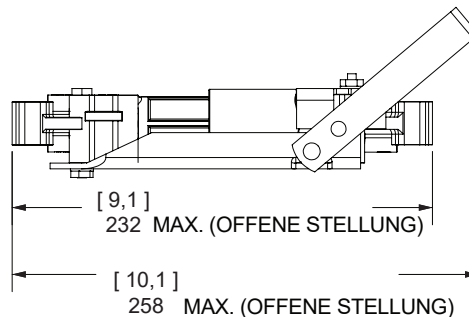
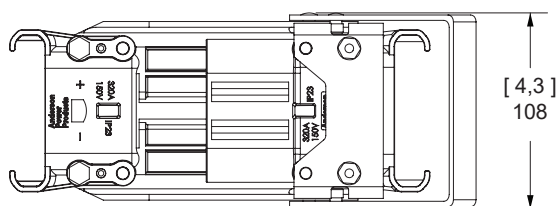

Batteriehalterung für zwei E160 & 320 DIN Stecker

Ladeanschluss am Gerät

Artikelnummer 994G6

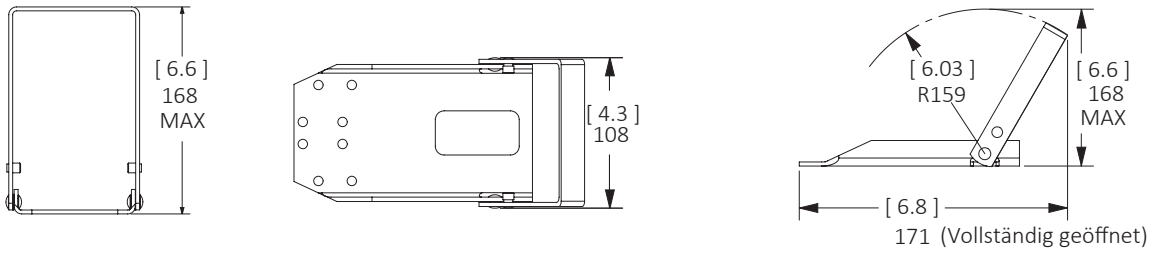

Batteriehalterung

Artikelnummer 993G6

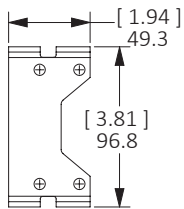

Batteriehalterung für zwei Steckverbinder

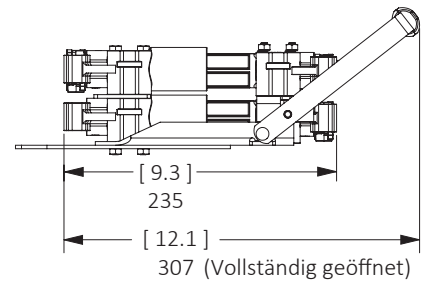
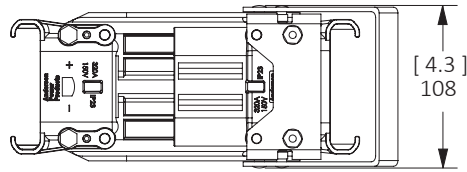

Manuelle Freigabe und Halterung für zwei Steckverbinder

Artikelnummer	Beschreibung
993G4	Batteriehalter mit manueller Entriegelung
993G6	Batteriehalterung für zwei Steckverbinder (Batterieseite)
994G4	Manuelle Entriegelung für DIN A160 & 320
994G6	Batteriehalterung für zwei Steckverbinder (Geräteseite)



Manuelle Freigabe



Batteriehalterung für zwei Steckverbinder

Kontakte						
Serie	Kabelquerschnitt		Flaches Profil		Hohes Profil	
	Metrisch	AWG	mm	Zoll	mm	Zoll
EBC 80	10 mm ²	6 bis 8	6,0	0,24	4,5	0,18
EBC 80 / 160	16 mm ²	4 bis 6	8,4	0,33	6,0	0,24
	25 mm ²	2 bis 4	11,0	0,43	8,0	0,31
	35 mm ²	1 bis 2	12,5	0,49	9,0	0,35
EBC 160 / 320	50 mm ²	1 bis 1/0	14,5	0,57	11,0	0,43
EBC 320	70 mm ²	2/0 bis 3/0	17,0	0,67	13,0	0,51
	95 mm ²	3/0 bis 4/0	19,8	0,78	15,0	0,59



Stromkontaktstecker

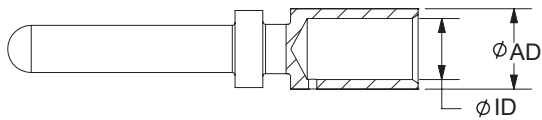

Stromkontaktbuchse

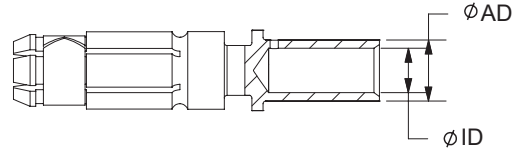

Serie	Obere Hilfsstecker				Untere Führungs-/Hilfsstecker							
	Kabelquerschnitt		AD		ID		Kabelquerschnitt		AD		ID	
	mm ²	AWG	mm	Zoll	mm	Zoll	mm ²	AWG	mm	Zoll	mm	Zoll
EBC 80	2,5	14 bis 18	3,9	0,15	2,2	0,09	2,5	14 bis 18	3,9	0,15	2,2	0,09
EBC 160 / 320	4	12	4,1	0,16	2,9	0,11	6,0	10	5,0	0,20	3,9	0,15

Oberer Hilfsstecker

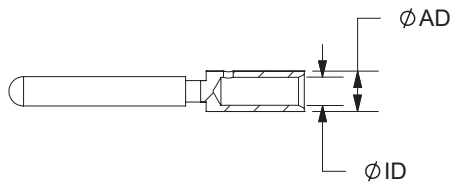

Obere Hilfsbuchse

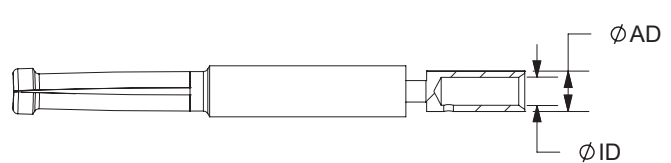

Unterer Führungs-/Hilfsstecker

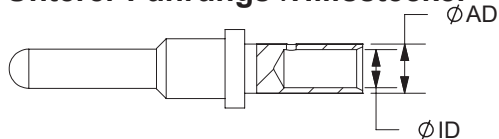

Untere Führungs-/Hilfsbuchse

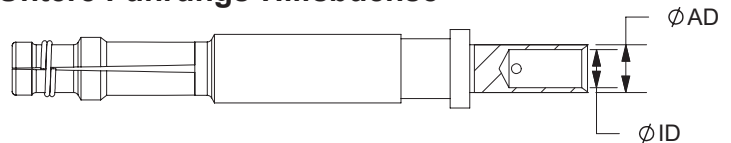

Gehäuse-Zwillingsluftadapter							Stecker-Zwillingsluftadapter					
Serie	G		H		J		G		H		J	
	mm	Zoll	mm	Zoll	mm	Zoll	mm	Zoll	mm	Zoll	mm	Zoll
EBC 80	102	4,0	15,8	0,62	13,0	0,51	87	3,4	15,8	0,62	13,0	0,51
EBC 160/320	154	6,1	17,8	0,70	13,9	0,55	125	4,9	17,8	0,70	14,0	0,55

Gehäuse-Luftadapter

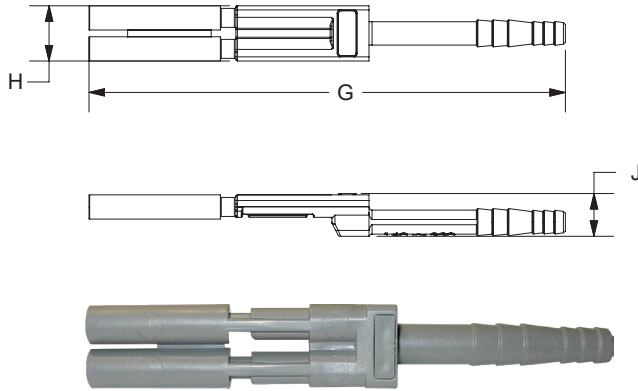

Stecker-Luftadapter

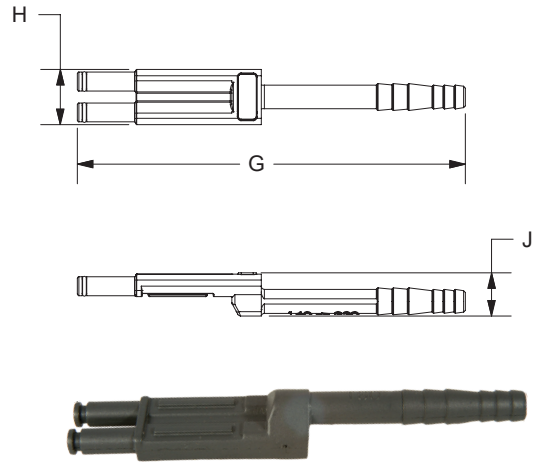

Spannungscodierstift für Nass-/Trockenzellen					Universeller Spannungscodierstift			
Serie	K		L		K		L	
	mm	Zoll	mm	Zoll	mm	Zoll	mm	Zoll
EBC 80	8,0	0,31	45	1,77	8,0	0,31	46	1,8
EBC 160/320	9,3	0,37	69	2,72	11,8	0,46	69	2,7

Spannungscodierstift für Nass-/Trockenzelle – Grau oder Grün

Codierstecker	Identifikation	Montiert in
	Verwendet für Nasszellenbatterie/ Ladegerät – Farbe Grau	Batterieanschlussbuchse und Ladestecker
	Verwendet für Trockenzellenbatterie/ Ladegerät – Farbe Grün	Batterieanschlussbuchse und Ladestecker
	Nur für Fahrzeug – Gelb (Universell)	Nur Fahrzeugstecker – wird verwendet, wenn im Fahrzeug Nass- oder Trockenzellenbatterien eingesetzt werden können.
	Batteriedose Batterie Lade-/Fahrzeugstecker Ladestation	Batterieanschluss und Ladestecker
	Batteriedose Batterie Lade-/Fahrzeugstecker Ladestation	Batterieanschluss und Ladestecker

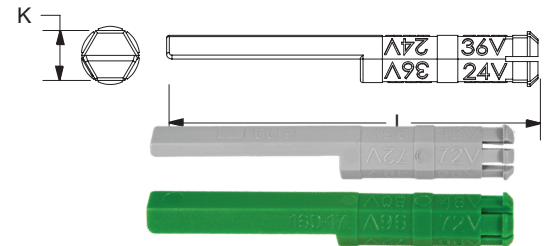

Universeller Spannungscodierstift – Gelb (Verwendung nur mit Steckergehäuse)

Universelle (gelbe) Spannungscodierstift dürfen nur auf der Fahrzeugseite verwendet werden, um die Verwendung mit Trocken- und Nasszellenbatterien zu ermöglichen.

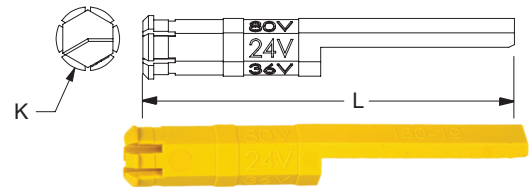

Schlüssel für Trockenzellenbatterie/Ladegerät Typ II – Blau (Männlich und weiblich)



Typ-II-Nasszellenbatterie-/Ladeschlüssel – Rot (Männlich und weiblich)



WERKZEUGINFORMATIONEN

EBC Series 80A, 160A, & 320A (DIN) - Hydraulische Werkzeuge											
Kabelquerschnitt		Teilenummern		Crimpwerkzeuge für lose Kontakte							
mm ²	AWG	Stromkontakt	Hydraulisches Handwerkzeug	+	Die	ODER	Hydraulisches Handwerkzeug				
10 mm ²	8 bis 6	80-1010	1387G3 ODER Cembre B500A ¹		1322G16		N/V				
		80-1110									
N/V	6	80-1016									
		80-1116									
16 mm ²	N/V	80-1016									
		80-1116									
25 mm ²	4 bis 2	80-1025									
		80-1125									
35 mm ²	2 bis 1	80-1035			N/V				1322G15		1368 Serie
		80-1135									
16 mm ²	6 bis 4	160-1016	1387G3 ODER Cembre B500A ¹		1322G9						
		160-1116									
25 mm ²	4 bis 2	160-1025									
		160-1125									
35 mm ²	2 bis 1	160-1035									
		160-1135									
50 mm ²	1 bis 1/0	160-1050									
		160-1150									
		320-1050									
		320-1150									
70 mm ²	2/0 bis 3/0	320-1070			1322G3 (K) *						
		320-1170			1322G2						
95 mm ²	3/0 bis 4/0	320-1095			1322G1						
		320-1195									
Pilot/Auxiliary Contacts											
ALLE		Stecker	NUR LÖTMASCHINE								
		Buchsen									

* 1322G3 nur mit K-Litze verwenden.

¹ www.Cembreinc.com



1387G3 oder Cembre B500A ¹



1368



1368-NL

EBC E80, E160, & E320 (DIN) – Pneumatische Werkzeuge

Kabelquerschnitt		Teilenummern		Crimpwerkzeuge für lose Kontakte			
mm ²	AWG	Stromkontakt	Pneumatisches Tischwerkzeug	+	Die	+	Locator (Einzel-Crimp)
10 mm ²	8 bis 6	80-1010	1387G2		1303G20		1304G4
		80-1110					
16 mm ²	6 bis 4	80-1016					
		80-1116					
25 mm ²	4 bis 2	80-1025	N/V		N/V		N/V
		80-1125					
35 mm ²	2 bis 1	80-1035					
		80-1135					
mm ²	AWG	Stromkontakt	Pneumatisches Tischwerkzeug	+	Die	+	Locator (Doppel-Crimp)
16 mm ²	6 bis 4	160-1016	1387G2		1303G14		1304G21 Buchse 1304G20 Stecker
		160-1116					
25 mm ²	4 bis 2	160-1025					
		160-1125					
35 mm ²	2 bis 1	160-1035					
		160-1135					
50 mm ²	1 bis 1/0	160-1050					
		160-1150					
		320-1050					
		320-1150					
70 mm ²	2/0 bis 3/0	320-1070					
		320-1170					
95 mm ²	3/0 bis 4/0	320-1095					
		320-1195					
Führungs-/Hilfskontakte							
ALLE		Alle Crimpstecker	NUR LÖTMASCHINE				
		Alle Crimpbuchsen					



1368-B



1387G1 & 1387G2

ADDITIONAL PRODUCTS FOR INDUSTRIAL VEHICLES



SBE®320 & SBX®350 - up to 550 Amps

- Touch Safe
- EN1175:2020
- Up to 8 Auxiliaries



SB® - up to 450 Amps

- Genderless Housings
- Hot Plugging AC or DC
- Keyed Housings

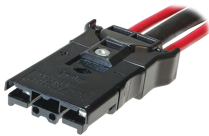

SBS®75X - up to 110 Amps

- Wire-to-Wire / Wire-to-Board
- Touch Safe Interface
- Ground or Auxiliary Positions



All Data Subject to Change Without Notice 2023-0112 DS-EBC REV 5 **Your Best Connection™**

Anderson™ will use reasonable efforts to include accurate and up-to-date content in the catalog. All product information contained in the catalog including ordering information, illustrations, specifications, and dimensions, are believed to be reliable as of the date of publishing, but is subject to change without notice. Anderson makes no warranty or representation as to its accuracy. Content in the catalog may contain technical inaccuracies, typographical errors and may be changed or updated without notice. Anderson may also make improvements and/or changes to the products and/or to the programs described in the content at any time without notice. Current sales drawings and specifications are available upon request. • Neither Anderson nor any party involved in creating, producing, or delivering this catalog shall be liable for any direct, incidental, consequential, indirect, or punitive damages arising out of your use of this catalog or any errors or omissions in its content. • All data subject to change without notice.

©2023 Anderson Power Products, Inc. All rights reserved. SB®, SBS®, SBE®, SBX®, Anderson Power Products®, are registered trademarks of Anderson Power Products, Inc. Anderson™, Anderson Power™, Anderson Power™ logo, and Your Best Connection™ are trademarks of Anderson Power Products, Inc.



HEADQUARTERS: Anderson Power Products®, 13 Pratts Junction Road, Sterling, MA 01564-2305 USA T: +1 978-422-3800 F: +1 978-422-0128 • **EUROPE:** Anderson Power Products® Ltd., Unit 3, Europa Court, Europa Boulevard, Westbrook, Warrington, Cheshire, WA5 7TN United Kingdom T: +44 (0) 1925 428390 F: +44 (0) 1925 520203
• **GERMANY:** IDEAL® Industries Germany GmbH, Esslinger Strasse 7, D – 70771 Leinfelden-Echterdingen, T: +49 (0) 711 – 997606666 • **ASIA / PACIFIC:** IDEAL® Anderson Asia Pacific Ltd., Unit 922-928 Topsail Plaza, 11 On Sum Street, Shatin N.T., Hong Kong T: +(852) 2636 0836 F: +(852) 2635 9036 • **INDIA:** IDEAL® INDUSTRIES India Private Limited, 229-230, SPAZEDGE, Tower B, Sector 47, Sohna Road, Gurgaon – 122018, Haryana, India T: +(91) 956-0075905 T: +(91) 124-4495101 • **CHINA:** IDEAL® Anderson Technologies (Shenzhen) Ltd., Block A8 Tantou Western Industrial Park, Songgang Baoan District, Shenzhen, PR. China 518105 T: +(86) 755 2768 2118 F: +(86) 755 2768 2218
• www.ideal-industries.in • www.andersonpower.com