

ANDERSONPOWER™

Crimp Specification for Powerpole® 75 & SB® 50 Contacts

		Powerpole® or SB®	MAX 		See "Resistance Test Setup"	See "Pull Test Setup"				
All Criteria Must Be Achieved for Proper Crimp Fit & Function										
Wire Size	Contact Series	Housing Series	Maximum Crimp Barrel Dimensions				Maximum Blade Angle Distortion (Degrees)	Silver Plated Contacts Milli-ohm Resistance (MAX)	Wire Pull Out Force (MIN) lb _f	Wire Pull Out Force (MIN) N
			X		Y					
			In	mm	In	mm				
#6 – 8 AWG	5900 & 1307	PP75	0.450	11.43	0.450	11.43	0.06	#6 = 100	#6 = 312	
	5952	SB® 50	0.447	11.35	0.450	11.43		#8 = 90	#8 = 401	
#10 AWG	5953 & 5915	PP75	0.450	11.43	0.450	11.43	0.10	80	356	
		SB® 50	0.447	11.35	0.450	11.43				
#12 AWG	5953 & 5915	PP75	0.450	11.43	0.450	11.43	0.18	70	312	
		SB® 50	0.447	11.35	0.450	11.43				

Measure Blade Angle

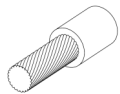
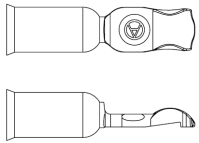
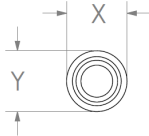
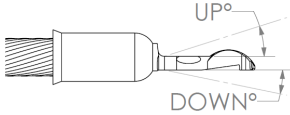
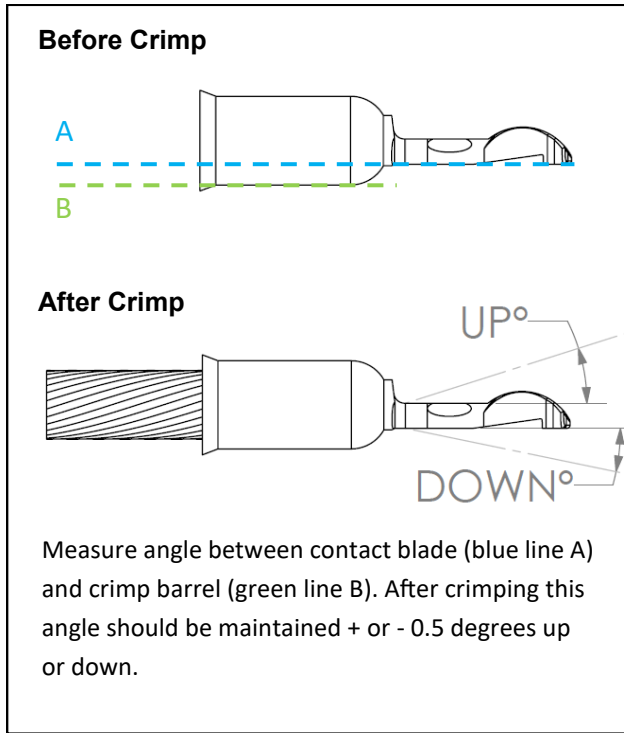

Pull Test Setup

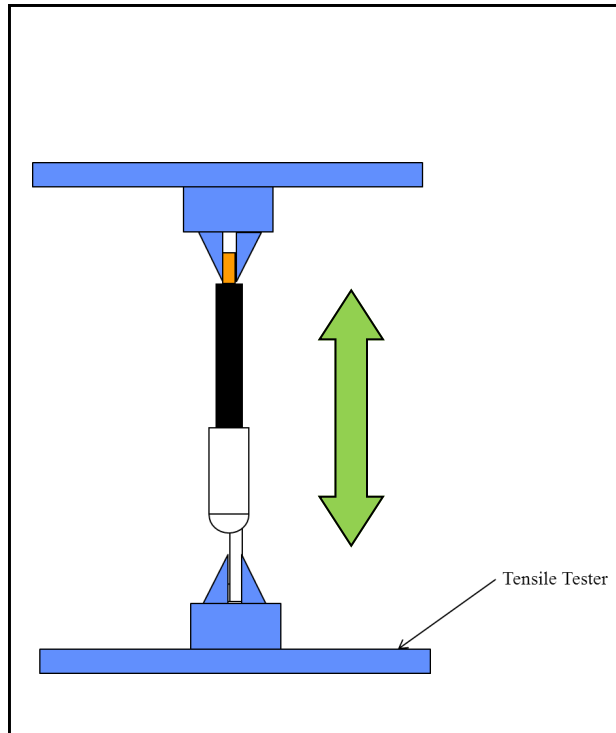

Resistance Test Setup

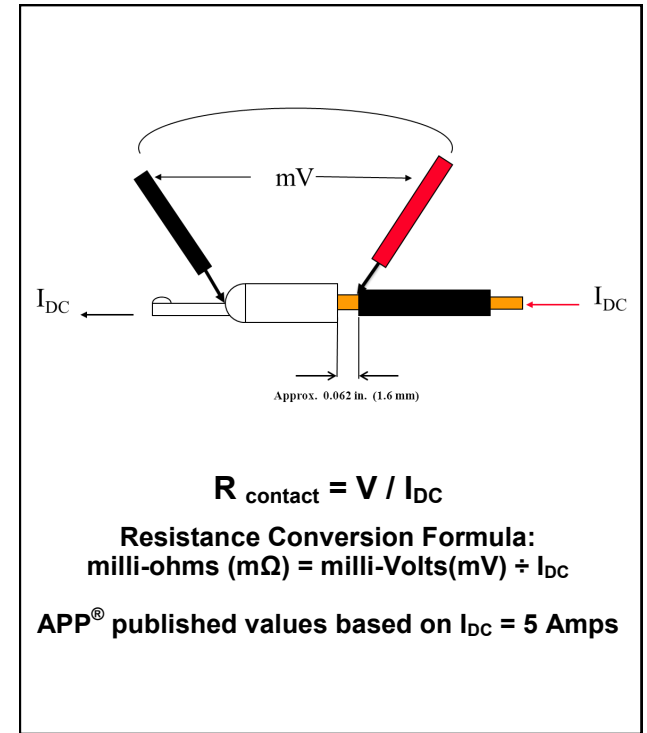

The included crimp performance and dimensional information are provided as a means to verify quality crimping of Anderson Power Products® contacts and is based on the use of tooling. The assembly of connector solutions with tooling assures that all crimp performance and fit specifications are met. Customers must regularly re-check electrical performance and dimensions of crimps to determine if crimp tools require maintenance due to wear over time.

The use of tooling not recommended can affect performance and may void the product warranty as well as invalidate safety agency approvals or certifications.

Dimensions of crimps meeting all four performance and fit requirements may be recorded and used as quality acceptance criteria:

(1) "Milli-ohm Resistance"	Primary inspection criteria. Crimps which do not meet these minimum specifications are unacceptable.
(2) "Wire Pull Out Force"	
(3) "Maximum Crimp Barrel Dimensions"	Not to be interpreted as target crimp dimensions. They are the maximum dimensions that allow the contact to properly fit into the connector housing. Actual dimension of acceptable quality crimps will be less than the "Max Dimensions" in at least one if not both dimensions.
(4) "Maximum Blade Angle Distortion"	Required to ensure proper contact retention in the housing. Out of specification contacts can increase milli-ohm resistance of an assembled mated pair of connectors. Contacts with unacceptable blade angle distortion cause connector mating and unmating forces to deviate from specification.

Quality crimping of the contact alone does not assure the installed performance of the connector system. Stress loads on the contacts from wires which have been bent or twisted near to the connector's wire exit may severely degrade connector performance. Wires should exit straight from the back of the connector and be secured before bending or twisting.

Reserves the right to make changes to either our products and/or support documentation as required without notice. Has used reasonable efforts to provide accurate and up-to-date content as of the date of publishing but is not responsible in case of typos or misprints. Customers are responsible to assure they are in possession the most recent documentation available. Current sales drawings and specifications are available on the website or upon request.

Makes no warranty that the products are appropriate for the customer's application and it is the responsibility of the customer to ensure crimp and connector performance meet end use requirements. Does not warranty that tooling will produce acceptable results with non-products.