

THE INFORMATION CONTAINED IN THIS DRAWING IS THE SOLE PROPERTY OF ANDERSON POWER PRODUCTS. ANY REPRODUCTION IN PART OR WHOLE WITHOUT THE WRITTEN PERMISSION OF ANDERSON POWER PRODUCTS IS PROHIBITED.

Copyright 1999

ANDERSON POWER PRODUCTS RESERVES THE RIGHT TO ALTER PRODUCT TYPES, THEIR TECHNICAL DATA, DIMENSION, STYLE AND ACCESSORIES WITHOUT PRIOR NOTIFICATION.

D
C
B
A

D
C
B
A

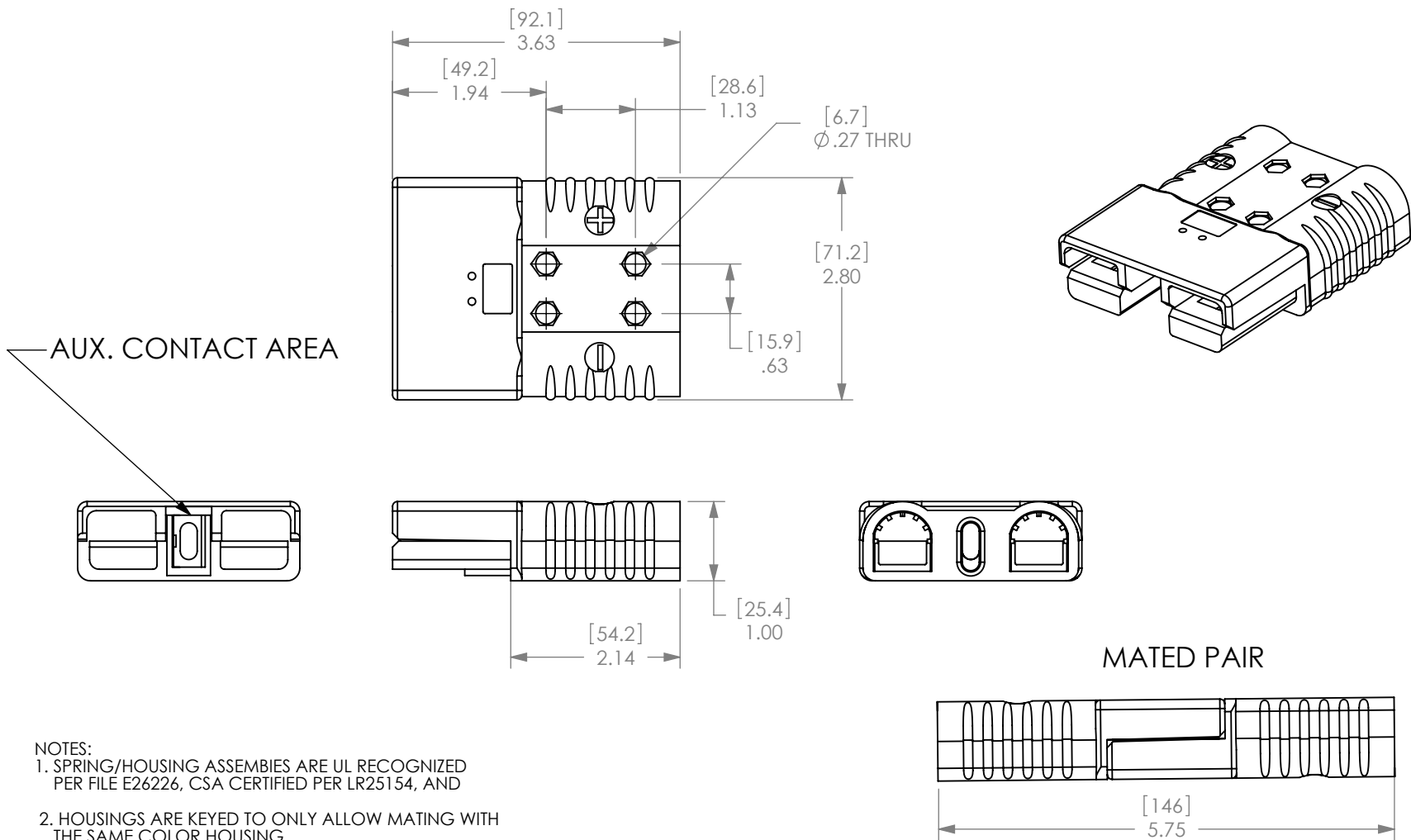

- NOTES:
1. SPRING/HOUSING ASSEMBLIES ARE UL RECOGNIZED PER FILE E26226, CSA CERTIFIED PER LR25154, AND
 2. HOUSINGS ARE KEYPED TO ONLY ALLOW MATING WITH THE SAME COLOR HOUSING
 3. FOR ASSEMBLY INSTRUCTIONS SEE DOCUMENT 1S1094
 4. HOUSINGS ASSEMBLIES ACCOMMODATE ANDERSON CONTACTS FOR WIRE RANGE FROM #10 AWG TO 1/0
 5. MATERIAL:
HOUSINGS- POLYCARBONATE, UL94V0
SPRING- STAINLESS STEEL
 6. OPTIONAL AUXILIARY CONTACT KIT AVAILABLE

DIMENSIONS ARE IN:		INCH [MM]		<i>APPROVALS</i>		ANDERSON POWER PRODUCTS	
UNLESS OTHERWISE STATED				DRAWN	CMS	4/2/1999	TITLE SBX 175 HOUSING AND SPRING ASSEMBLY OUTLINE DRAWING
TOLERANCES:				CHECKED	DJD	4/3/1999	
DECIMALS (INCH)	DECIMALS (MM)	ANGLES		MFG APPRV	CHB	4/20/1999	
.XX ± .015	.X ± .38	±.5°		QC APPRV	PC	4/20/1999	
.XXX ± .005	.XX ± .13			ENG APPRV	UFN	4/13/1999	
SURFACE FINISH:				MATERIAL:		SIZE	
MACHINED		128µin [3.2µ]		SEE NOTES		A	DWG NO.
MOLDED		64µin [1.6µ]		FINISH:		A	114135S1
				3rd ANGLE PROJECTION		SCALE	
						1:2	
						CADFILE	
						01004	
						SHEET	
						1 OF 2	
						-CAD GENERATED DRAWING- DO NOT MANUALLY UPDATE DO NOT SCALE	

1	ECRN-14934 COLOR AND KEYING ADDED	TWE	7/13/11
REV.	DESCRIPTION	APPRV	DATE
REVISIONS			

THE INFORMATION CONTAINED IN THIS DRAWING IS THE SOLE PROPERTY OF ANDERSON POWER PRODUCTS. ANY REPRODUCTION IN PART OR WHOLE WITHOUT THE WRITTEN PERMISSION OF ANDERSON POWER PRODUCTS IS PROHIBITED.

Copyright 2011

ANDERSON POWER PRODUCTS RESERVES THE RIGHT TO ALTER PRODUCT TYPES, THEIR TECHNICAL DATA, DIMENSION, STYLE AND ACCESSORIES WITHOUT PRIOR NOTIFICATION.

D

D

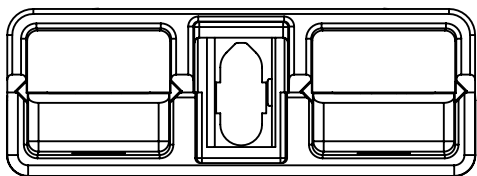

GRAY VOLTAGE KEY

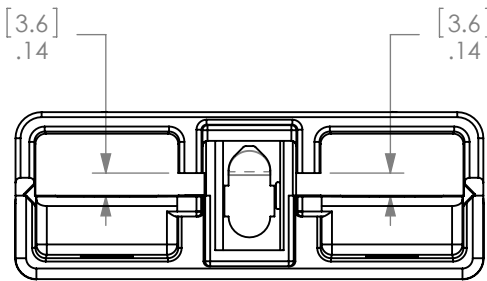

BLUE VOLTAGE KEY

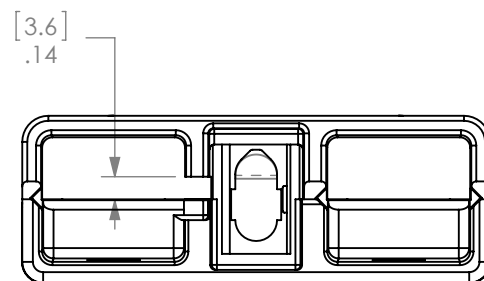

ORANGE VOLTAGE KEY

C

C

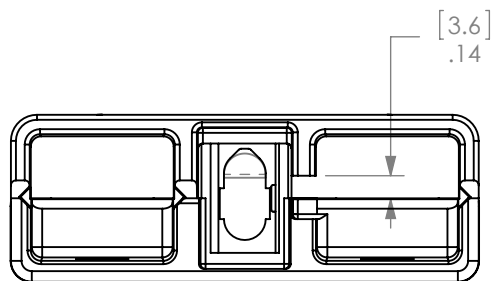

YELLOW VOLTAGE KEY

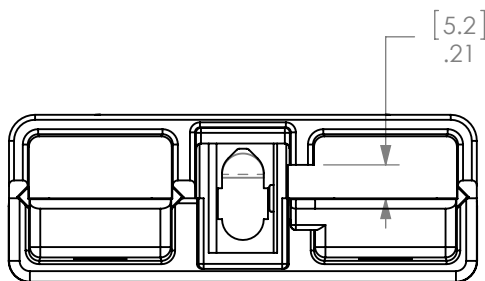

RED VOLTAGE KEY

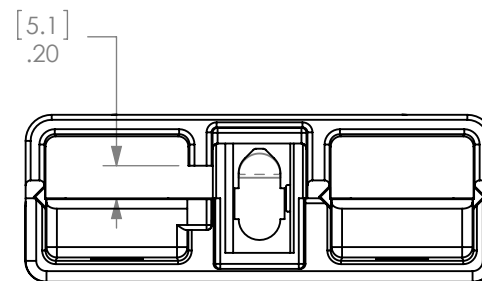

GREEN VOLTAGE KEY

B

B

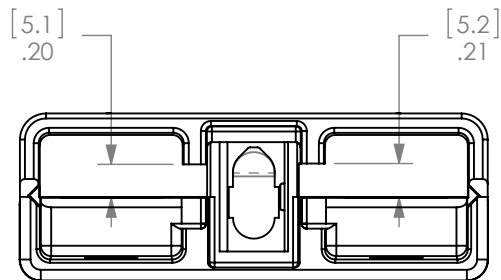

BLACK VOLTAGE KEY

A

A

DIMENSIONS ARE IN:		INCH [MM]		<i>APPROVALS</i>		ANDERSON POWER PRODUCTS	
UNLESS OTHERWISE STATED				DRAWN		TITLE	
TOLERANCES:				CMS 4/2/99		SBX 175 HOUSING AND SPRING ASSEMBLY OUTLINE DRAWING	
DECIMALS (INCH)		DECIMALS (MM)		CHECKED			
.XX ± .02		.X ± .5		DJD 4/3/99			
ANGLES ±2°				MFG APPRV			
SURFACE FINISH:				CHB 4/20/99			
MACHINED 128µin [3.2µ]		MOLDED 64µin [1.6µ]		QC APPRV			
MATERIALS: SEE NOTES				PC 4/20/99			
FINISH:				ENG APPRV		SIZE A DWG NO. 114135S1 REV. 1	
				UFN 4/20/99		SCALE NONE CADFILE 01004 SHEET 2 OF 2	
-CAD GENERATED DRAWING- DO NOT MANUALLY UPDATE DO NOT SCALE							

-	See Sheet1	-	-
REV.	DESCRIPTION	APPRV	DATE
REVISIONS			