

THE INFORMATION CONTAINED IN THIS DRAWING IS THE SOLE PROPERTY OF ANDERSON POWER PRODUCTS. ANY REPRODUCTION IN PART OR WHOLE WITHOUT THE WRITTEN PERMISSION OF ANDERSON POWER PRODUCTS IS PROHIBITED.

Copyright 1999

ANDERSON POWER PRODUCTS RESERVES THE RIGHT TO ALTER PRODUCT TYPES, THEIR TECHNICAL DATA, DIMENSION, STYLE AND ACCESSORIES WITHOUT PRIOR NOTIFICATION.

D
C
B
A

D
C
B
A

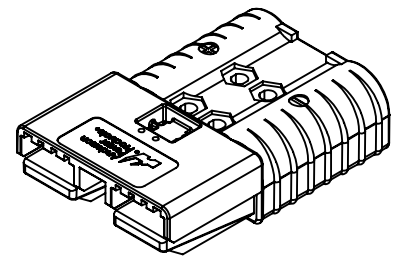
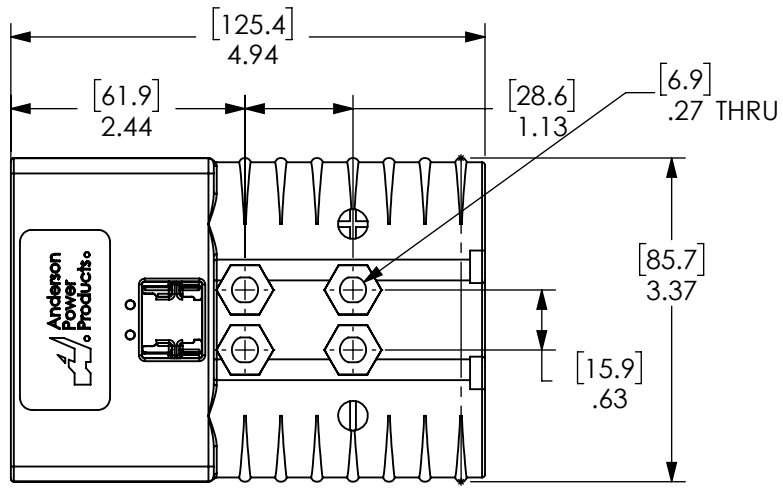

AUXILIARY CONTACT AREA

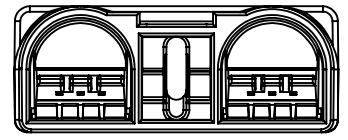
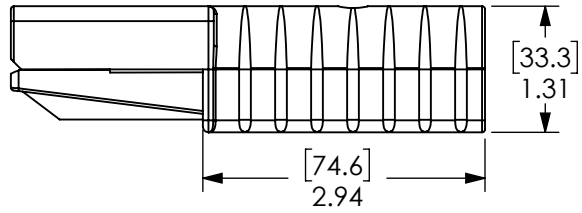
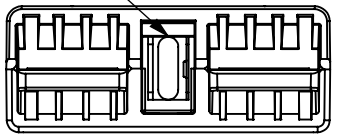

MATED PAIR

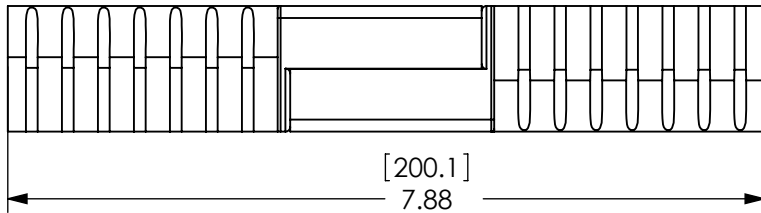

- NOTES:
1. SPRING/HOUSING ASSEMBLIES ARE UL RECOGNIZED PER FILE E26226, CSA CERTIFIED PER LR25154, AND
 2. HOUSINGS ARE KEYPED TO ONLY ALLOW MATING WITH THE SAME COLOR HOUSING
 3. FOR ASSEMBLY INSTRUCTIONS SEE DOCUMENT 1S1094
 4. HOUSINGS ASSEMBLIES ACCOMODATE ANDERSON CONTACTS FOR WIRE RANGE FROM #2 AWG TO 300MCM
 5. MATERIAL:
HOUSINGS- POLYCARBONATE, UL94V0
SPRING- STAINLESS STEEL
 6. OPTIONAL AUXILIARY CONTACT KIT AVAILABLE

REV.	DESCRIPTION	APPRV	DATE
3	ECN 2015-0001	CMS	12/13/2016
2	ECRN-15787A	TWE	3/5/2015
1	ECRN-14934 COLOR AND KEYING ADDED	TWE	7/13/11

REVISIONS

DIMENSIONS ARE IN:	INCH [MM]	APPROVALS	
UNLESS OTHERWISE STATED		DRAWN	
TOLERANCES:		CMS	4/2/1999
DECIMALS (INCH)	DECIMALS (MM)	CHECKED	
.XX ± .02	.X ± .5	DJD	4/3/1999
ANGLES ±2°		MFG APPRV	
SURFACE FINISH:		CHB	4/20/1999
MACHINED	128µin [3.2µ]	QC APPRV	
MOLDED	64µin [1.6µ]	DJM	4/20/1999
MATERIAL:		ENG APPRV	
SEE NOTES		UFN	4/13/1999
FINISH:			

ANDERSON POWER PRODUCTS

TITLE

SBX 350 HOUSING AND SPRING ASSEMBLY OUTLINE DRAWING

SIZE	DWG NO.	REV.
A	114136S1	3

3rd ANGLE PROJECTION

-CAD GENERATED DRAWING-
DO NOT MANUALLY UPDATE
DO NOT SCALE

SCALE	CADFILE	SHEET
NONE	01005	1 OF 2

8 7 6 5 4 3 2 1

THE INFORMATION CONTAINED IN THIS DRAWING IS THE SOLE PROPERTY OF ANDERSON POWER PRODUCTS. ANY REPRODUCTION IN PART OR WHOLE WITHOUT THE WRITTEN PERMISSION OF ANDERSON POWER PRODUCTS IS PROHIBITED.

Copyright 2011

ANDERSON POWER PRODUCTS RESERVES THE RIGHT TO ALTER PRODUCT TYPES, THEIR TECHNICAL DATA, DIMENSION, STYLE AND ACCESSORIES WITHOUT PRIOR NOTIFICATION.

D

D

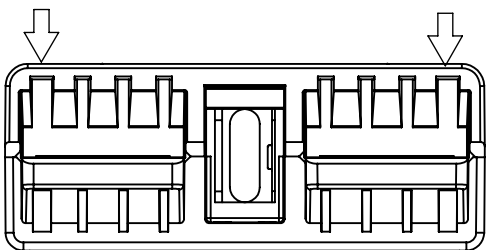

GRAY KEYING

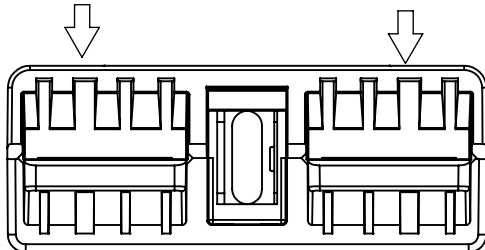

BLUE KEYING

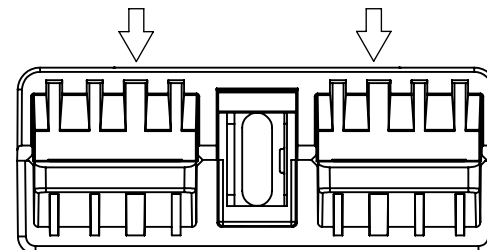

RED KEYING

C

C

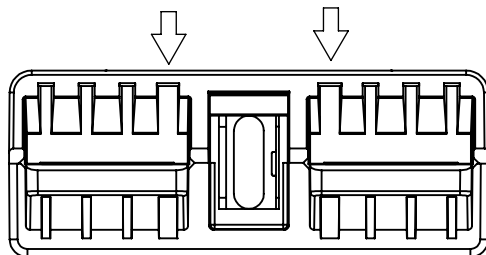

GREEN KEYING

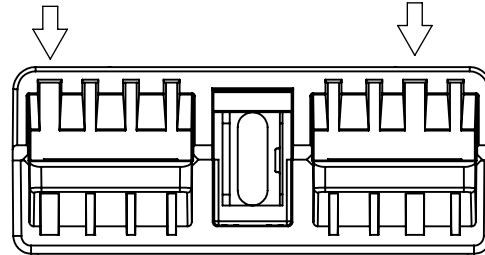

BLACK KEYING

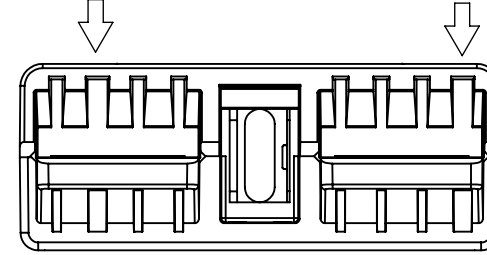

YELLOW KEYING

B

B

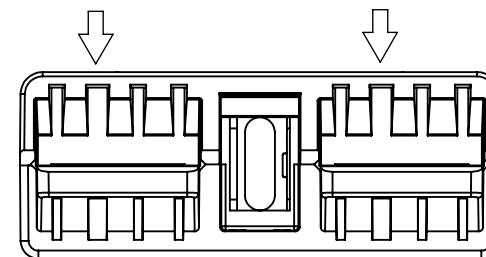

ORANGE KEYING

**NOTE:
DIFFERENT COLOR KEYING IS BASED ON LOCATION
OF WIDE KEY, HIGHLIGHTED WITH ARROWS**

DIMENSIONS ARE IN: INCH [MM]		<i>APPROVALS</i>			ANDERSON POWER PRODUCTS	
UNLESS OTHERWISE STATED		DRAWN	CMS 4/2/99		TITLE SBX 350 HOUSING AND SPRING ASSEMBLY OUTLINE DRAWING	
TOLERANCES:		CHECKED	DJD 4/3/99	MFG APPRV CHB 4/20/99		
DECIMALS (INCH) .XX ± .02	DECIMALS (MM) .X ± .5	ANGLES ±2°		QC APPRV DJM 4/20/99		
SURFACE FINISH:		ENG APPRV UFN 4/13/99		SIZE	DWG NO.	REV.
MACHINED	128µin [3.2µ]			A	114136S1	3
MOLDED	64µin [1.6µ]			SCALE	CADFILE	SHEET
MATERIAL: SEE NOTES				NONE	01005	2 OF 2
FINISH:				-CAD GENERATED DRAWING- DO NOT MANUALLY UPDATE DO NOT SCALE		

A

A

-	See Sheet1	-	-
REV.	DESCRIPTION	APPRV	DATE
REVISIONS			

8 7 6 5 4 3 2 1