

8 7 6 5 4 3 2 1

THE INFORMATION CONTAINED IN THIS DRAWING IS THE SOLE PROPERTY OF ANDERSON POWER PRODUCTS. ANY REPRODUCTION IN PART OR WHOLE WITHOUT THE WRITTEN PERMISSION OF ANDERSON POWER PRODUCTS IS PROHIBITED.

Copyright 2013

ANDERSON POWER PRODUCTS RESERVES THE RIGHT TO ALTER PRODUCT TYPES, THEIR TECHNICAL DATA, DIMENSION, STYLE AND ACCESSORIES WITHOUT PRIOR NOTIFICATION.

COMPONENTS INCLUDED		
ITEM	QTY	DESCRIPTION
1	1	STRAIGHT PLUG SHELL (FEMALE) WITH O-RING

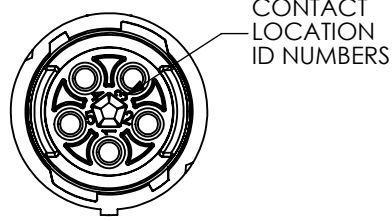
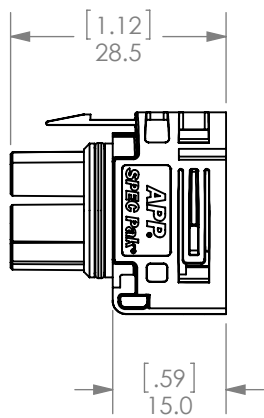
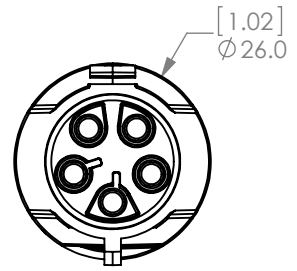
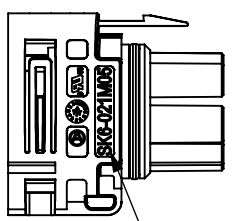
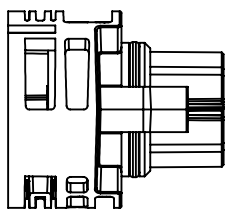
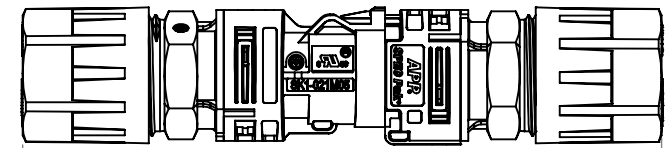
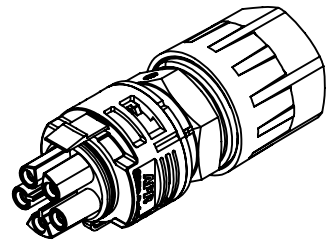
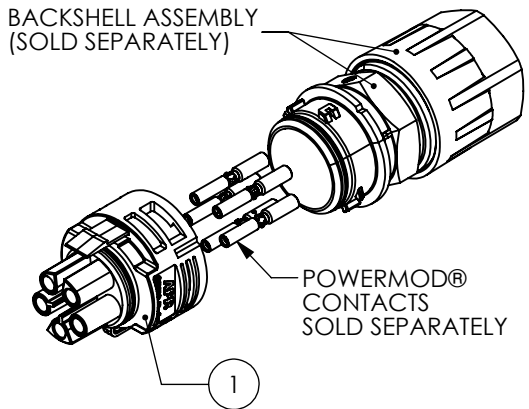

PART NUMBER (SEE SHEET 2 FOR KEYING)

PART NO: SK6-021M05
SEE SHEET 2 FOR ADDITIONAL KEYS

- NOTES:
- MATERIAL
 - A. PLUG SHELL - PC, BLACK
 - B. O-RING - NBR, BLACK
 - FOR USE WITH POWERMOD® SOCKET CONTACTS (SOLD SEPARATELY)
 - REFER TO ASSEMBLY INSTRUCTIONS 1S6616

DIMENSIONS ARE IN:	MM [INCH]	APPROVALS			ANDERSON POWER PRODUCTS		
UNLESS OTHERWISE STATED		DRAWN	10/7/2013		TITLE		
TOLERANCES:		CHECKED	1/23/2014	5-POSITION MINI-PL SPEC PAK® STRAIGHT PLUG SHELL (FEMALE)			
DECIMALS (INCH)	DECIMALS (MM)	ANGLES					
.XX ±.02	.X ±.5	±2°					
SURFACE FINISH:		MFG APPRV	1/24/2014	SIZE			
MACHINED	3.2µ [128µin]	CHB					
MOLDED	1.6µ [64µin]	QC APPRV	1/20/2014	115306S1		1	
MATERIAL:		ENG APPRV	1/23/2014	SCALE		CADFILE	SHEET
SEE NOTE 1		CMS		NONE		04070	1 OF 2
FINISH:		-CAD GENERATED DRAWING- DO NOT MANUALLY UPDATE DO NOT SCALE					

1	ECRN-15568	TWE	2/6/2014
REV.	DESCRIPTION	APPRV	DATE
REVISIONS			

8 7 6 5 4 3 2 1

8 7 6 5 4 3 2 1

THE INFORMATION CONTAINED IN THIS DRAWING IS THE SOLE PROPERTY OF ANDERSON POWER PRODUCTS. ANY REPRODUCTION IN PART OR WHOLE WITHOUT THE WRITTEN PERMISSION OF ANDERSON POWER PRODUCTS IS PROHIBITED.

Copyright 2013

ANDERSON POWER PRODUCTS RESERVES THE RIGHT TO ALTER PRODUCT TYPES, THEIR TECHNICAL DATA, DIMENSION, STYLE AND ACCESSORIES WITHOUT PRIOR NOTIFICATION.

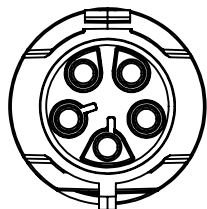

SK6-021M05

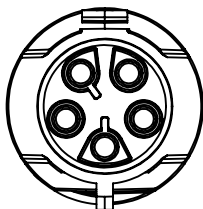

SK6-A21M05

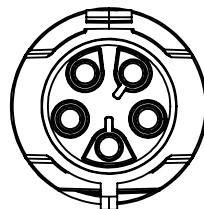

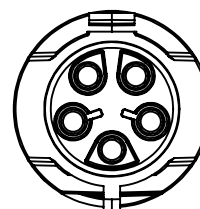

SK6-B21M05



SK6-F21M05

NOTE:
CONTACT FACTORY FOR
ADDITIONAL KEYS

DIMENSIONS ARE IN:		MM [INCH]	APPROVALS		 ANDERSON POWER PRODUCTS	
UNLESS OTHERWISE STATED			DRAWN	NTS		10/7/2013
TOLERANCES:			CHECKED	MM		1/23/2014
DECIMALS (INCH)	DECIMALS (MM)	ANGLES	MFG APPRV	CHB		1/24/2014
.XX ± .02	.X ± .5	±2°	QC APPRV	UFN	1/20/2014	
SURFACE FINISH:			ENG APPRV	CMS	1/23/2014	
MACHINED	3.2µ [128µin]	✓	SIZE A DWG NO. 115306S1 REV. 1 SCALE NONE CADFILE 04070 SHEET 2 OF 2			
MOLDED	1.6µ [64µin]	✓				
MATERIAL: SEE NOTE 1			-CAD GENERATED DRAWING- DO NOT MANUALLY UPDATE DO NOT SCALE			
FINISH:						

REV.	DESCRIPTION	APPRV	DATE
-	See Sheet1	-	-
REVISIONS			

8 7 6 5 4 3 2 1