

SBS[®] X-75A



Dust- Water- Shock

Sealed Connector Series

- Industrial / Commercial • Power Equipment • Material Handling / Automation
- Agricultural / Construction • Lawn / Garden Equipment • Marine



**ANDERSON
POWER™**

SBS®X-75A

The SBS®X-75A sealed waterproof connectors come in a multiple of configuration offerings with up to a maximum of 140A of power and the durability of up to 5,000 mating cycles. Positive metal latches help safeguard against accidental disconnects that may be caused by vibration, while the built-in cable clamp allows for strain relief on wires.

The compact sleek high-power design of these environmentally rugged connectors makes them ideal for outdoor applications. The IP68 weatherproof rating ensures that the connector will be free of water for full protection up to 30 minutes at 6 feet in the mated conditions, or with the use of covers in unmated condition.



600 Volts / 140A



5,000 Mating Cycles



Operating Temperature
-20°C to 105°C / -4 °F to 221°F



Dust - Water - Shock

SPECIFICATIONS

ELECTRICAL							
Current Rating Amperes ¹		Power Only		4 Pole		6 Pole	
Wire to Wire		No Signals		Signals Energized 20 AWG - 10 amps		Signals Energized Using PPMX Contacts (20 AWG - 3 amps)	
AWG	mm ²	UL	CSA	UL	CSA	UL	CSA
4 AWG	25	140	85	135	80	125	75
6 AWG	16	100	65	95	60	N/A	N/A
8 AWG	10	95	58	93	53	93	53
10 AWG	6	75	45	75	45	N/A	N/A
Wire to Wire & Wire to Panel Mount with Ground*		90	65	N/A	N/A	N/A	N/A
6 AWG (16 mm ²) Wire							
Wire Plug to Panel Mount Receptacle							
4 AWG (25 mm ²) Wire		145	90	140	85	N/A	N/A
Panel Mount Plug to Panel Mount Receptacle							
4 AWG (25 mm ²) Wire		140	85	135	80	N/A	N/A
Voltage Rating AC/DC							
UL 1977		600V		600V		600V	
Dielectric Withstanding Voltage							
Volts AC		2,200		2,200		2,200	
Average Mated Contact Resistance Milliohms ¹							
Power 1/4 in. of 4 AWG (25 mm ²) Wire		0.16m Ω		0.16m Ω		0.16m Ω	
Ground 1/4 in. of 6 AWG (16 mm ²) Wire		0.22m Ω		N/A		N/A	
Auxiliary 14 AWG (1.0 to 1.5 mm ²) Wire		2.50m Ω		2.50m Ω		20 AWG (.25mm ²) 3 amps - 9.0 Ω	
UL Hot Plug Current Rating Amperes		250 cycles at 120V DC		250 cycles at 120V DC			
4 AWG (25 mm ²) Wire		50A		50A			
Ground Short Time Current Test							
1530 Amps (6 AWG / 16mm ²) Wire		6 Seconds					
Touch Safe		Per UL 60950-1, UL 62368-1 & IEC 60529 ³			Per UL 60950-1, UL 62368-1 & IEC 60529 ³		
*Ground is not rated for current interruption (hot plug) when energized or touch safe.							

MECHANICAL	4 Pole	6 Pole		
Wire Size Range				
Power Contacts	10 to 4 AWG (2.5 to 25.0 mm ²)	10 to 4 AWG (2.5 to 25.0 mm ²)		
Auxiliary Contacts	14 to 24 AWG (1.5 mm ² to 0.50)	24 to 20 AWG (0.50 to 0.75 mm ²)		
Pre-Mate Contacts Ground Only 12 to 6 AWG (2.5 to 16mm ²)				
Maximum Wire Insulation Diameter				
Power/Ground	0.44 in. (11.18 mm)	0.44 in. (11.18 mm)		
Auxiliary	0.44 in.(11.18 mm)	Discrete Wires- 20 AWG; 0.09 in. (2.29 mm) 6 Cond. Jacketed Cable- 0.021 in. (5.33 mm)		
Operating Temperature ² -20° to 105°C (-4 to 221°F)				
Mating Cycles No Load by Plating 5,000				
Average Mating / Unmating Force				
Wire = Lbs / Kg	4 AWG (25 mm ²) = 6.5 Lbs (2.95 Kg)	4 AWG (25 mm ²) = 6.5 Lbs (2.95 Kg)		
Ground Wire = Lbs / Kg 6 AWG (16mm ²) / 12 Lbs (5.44 Kg)				
Minimum Creepage / Clearance Distance				
	Creepage	Clearance	Creepage	Clearance
Power to Power	1.50 in. (38.1 mm)	0.900 in. (22.86 mm)	1.50 in. (38.1 mm)	0.900 in. (22.86 mm)
Power to Signal	1.12 in. (28.4 mm)	0.640 in. (16.26 mm)	1.727 in. (43.87 mm)	0.397 in. (10.08 mm)
Pin to Pin	0.097 in. (2.46 mm)	0.097 in. (2.46 mm)	0.194 in. (4.93 mm)	0.194 in. (4.93 mm)
Socket to Socket	0.352 in. (8.94 mm)	0.352 in. (8.94 mm)	0.157 in. (3.99 mm)	0.157 in. (3.99 mm)
Pin to Socket	1.15 in. (29.21 mm)	0.485 in. (12.3 mm)	0.535 in. (13.59 mm)	0.337 in. (8.56 mm)
Power to Ground Creepage = 1.20" (30.5mm) Clearance =0.28" (7.1mm)				
Pull Out Force with Cable Clamp		60 lb. [267N]	60 lb. [267N]	
Pull Out Force with Cable Clamp Ground Only 60lb. [267N]				
Push Out Retention Force Auxiliary		35 lb. [156N]	35 lb. [156N]	
Pull Out Retention Contact Holder (part no. 2-8859P1)			20 lb. [89N]	
Drop Test		Per UL 486A-486B	Per UL 486A-486B	
Drop Test Ground		Per UL 486A-486B		
IP68		Per UL50E ⁴	Per UL50E ⁴	
IP68 Ground		Per UL50E ⁴		

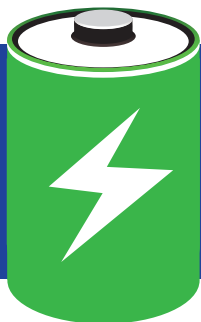

600 Volts / 140A

MATERIALS		
Housing, Cable Clamps, Covers	PC/PBT	PC/PBT
Signal / Ground Housing	PC	PC
Latches, Spring, Screws	Stainless Steel	Stainless Steel
O-Rings, Grommets	Silicone	Silicone
Panel Mount Gasket	NBR	NBR
Housing Flammability Rating	UL94 V0	UL94 V0
Glow Wire (1.0 mm)	960°C per 60695-2-12	960°C per 60695-2-12
Wire Power Contact	Silver Plated Copper Alloy	Silver Plated Copper Alloy
SBS® 75X Auxiliary Contacts		
Pin	Copper Alloy, Au over Ni	Gold Plated Copper Alloy
Socket	Be Cu, Au over Ni	Gold Plated Copper Alloy
Socket Body	Copper Alloy, Tin Bright over Ni	Copper Alloy, Tin Bright over Ni
Retention Clip	Stainless Steel	Stainless Steel

NOTES:

- 1 - Current amperage ratings are based on 105°C rated or better cable of the largest wire size using properly calibrated Anderson recommended tooling, and a 25°C ambient temperature, or CSA rating below a 30°C temperature rise. UL rating not to exceed the maximum operating temperature. Connector to be assembled and installed according to the manufacturer’s instructions.
- 2 - Operating Temperatures are limited by the thermal properties of the connector’s plastic housing.
- 3 - Sealed Connector Series offers protection against electric shock for finger safety both in mated and unmated condition. The Sealed SBS®X-75A Connector Series was tested for IP Code 1X-2X per clause 12- & 13 of IEC 60529 , Edition 2.2, issued 2013-8 + Corr. 1:2013-10 + Corr. 2:2015-01. The connector was tested for IP1X and IP2 in mated and unmated condition, which is representative of protection against access to energized parts contained in UL 60950-1 2nd Edition, 2011-12-19 and UL 62368-1 3rd Edition, 2021-10-22.
- 4 - The Sealed SBS®X-75A Connector Series was subjected to submersion test, covered by UL 50E Standard for Enclosures for Electrical Equipment Environmental Considerations, 3rd Edition, with a pressure equivalent to 6 feet of water and for a duration of 30 minutes for the equivalent IP68 compliance. Note panel mount-to-panel mount configuration has not been tested for ingress protection rating: contact manufacturer to determine if it will work for your application.
- 5 - 6 position auxiliary housing utilizes PPMX contacts.
- 6 - It is recommended that for SBS®X-75A, customers use individual discrete wires for power, and jacketed cables for signaling to limit strain on smaller auxiliary wires.

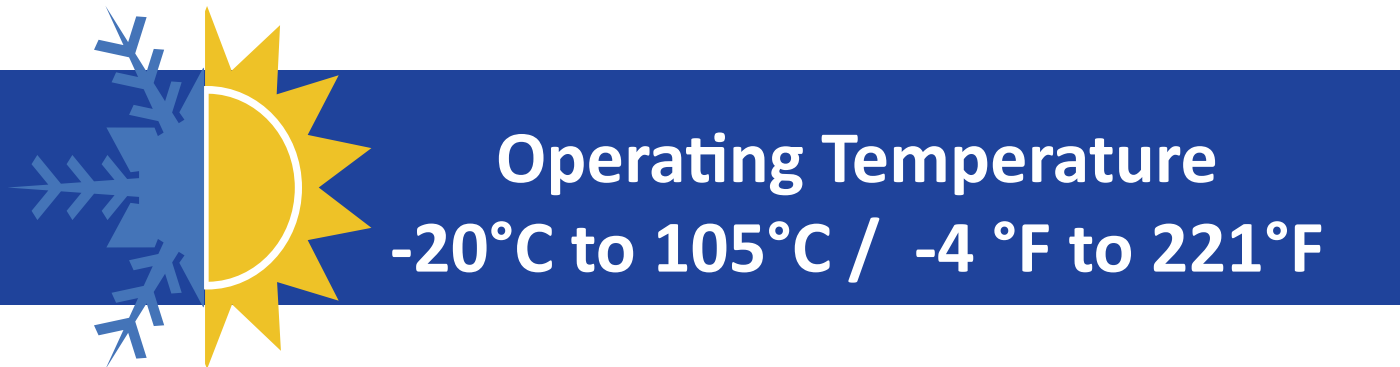

TEMPERATURE CHARTS

SBS®X-75A Power Contacts Only Energized
Temperature Rise at Constant Current

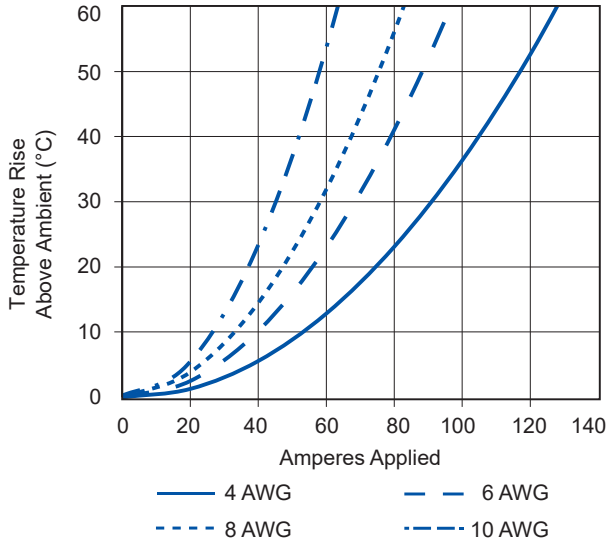

SBS®X-75A Power Contacts Only Energized
Derating vs. Ambient Temperature

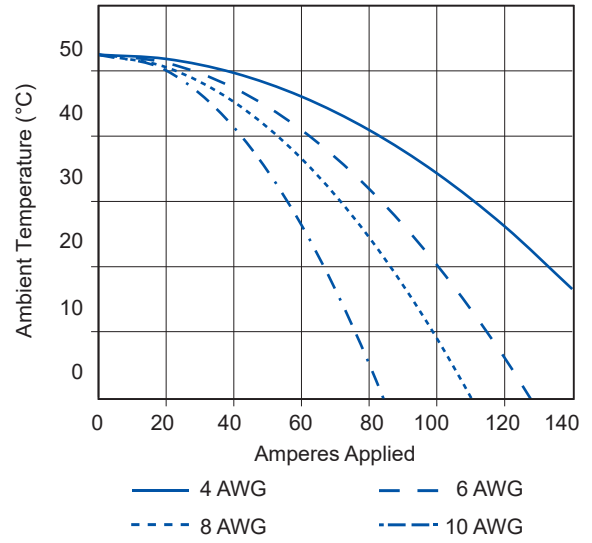

SBS®X-75A 4-Position Auxiliary Contacts at 10A
Temperature Rise at Constant Current

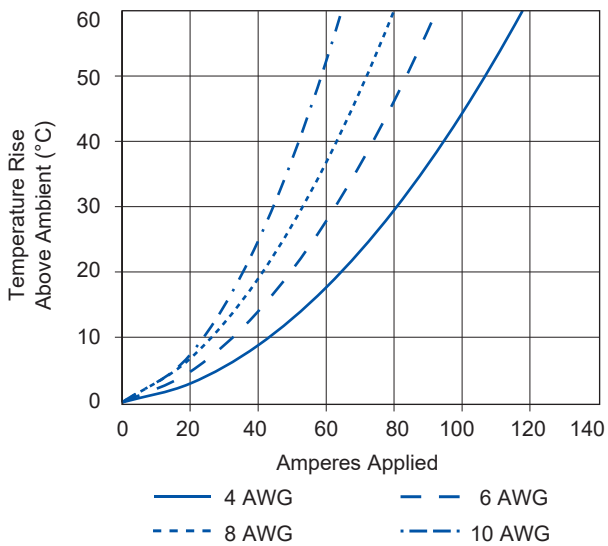

SBS®X-75A 4-Position Auxiliary Contacts at 10A
Derating vs. Ambient Temperature

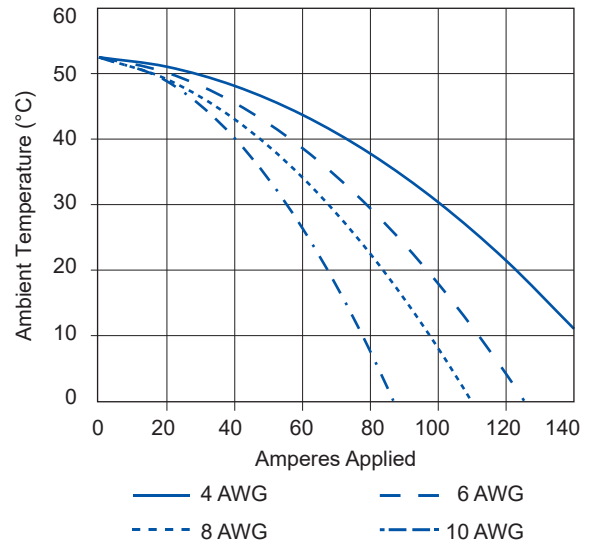

SBS®X-75A 6-Position Auxiliary Contacts at 3A
Temperature Rise at Constant Current

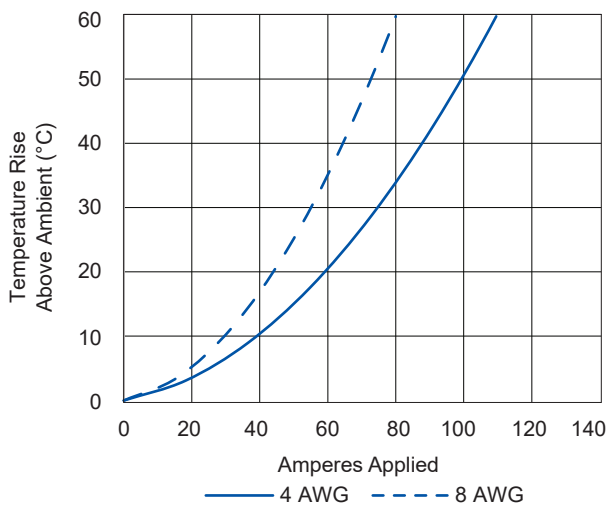

SBS®X-75A 6-Position Auxiliary Contacts at 3A
Derating vs. Ambient Temperature

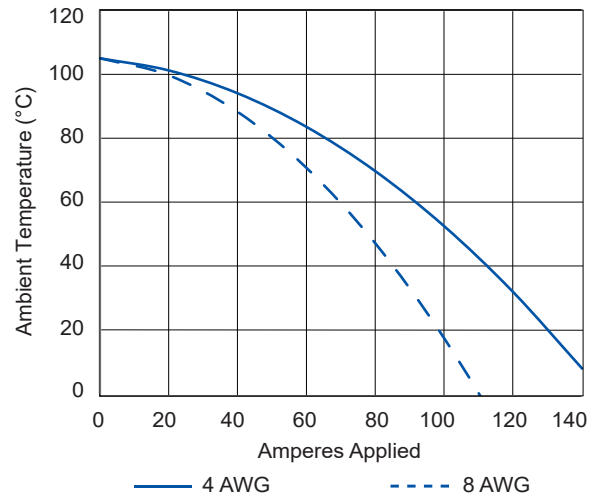

COMPONENTS - *Center Signal housings are available in 4 or 6 positions. See ordering section for details.

Wire-to-Wire

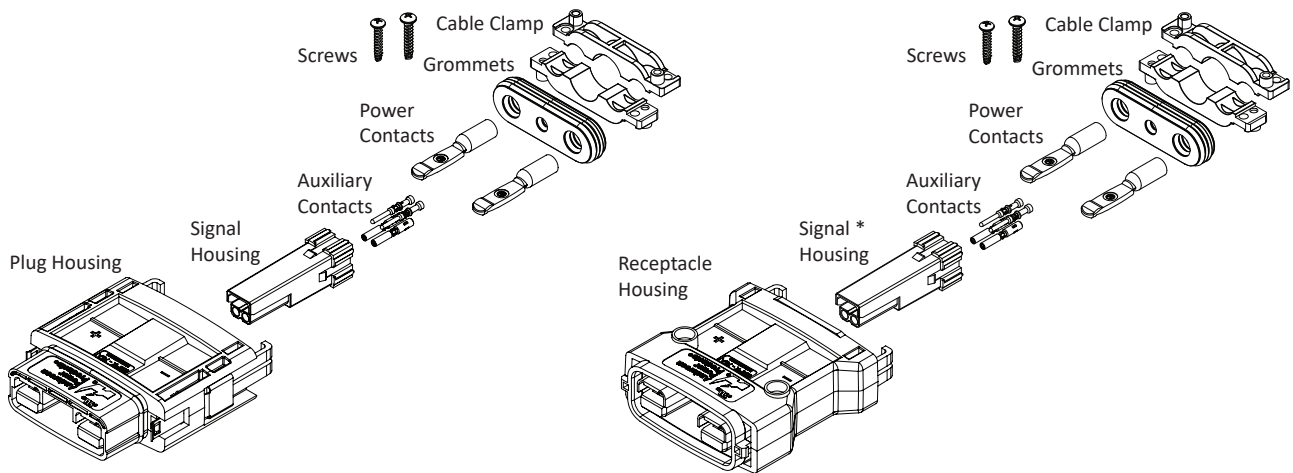

Wire-to-Panel Mount

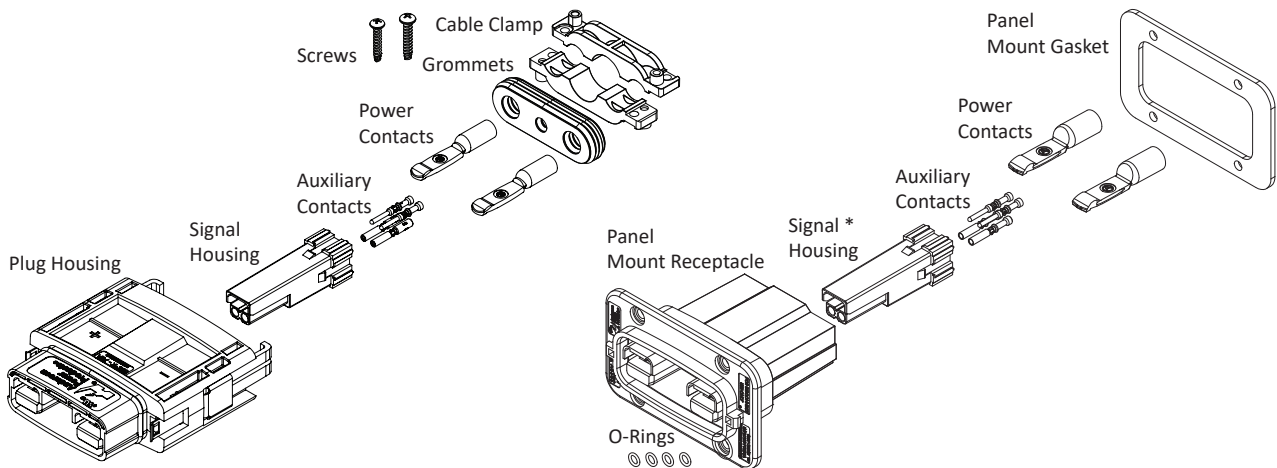

Panel Mount-to-Panel Mount

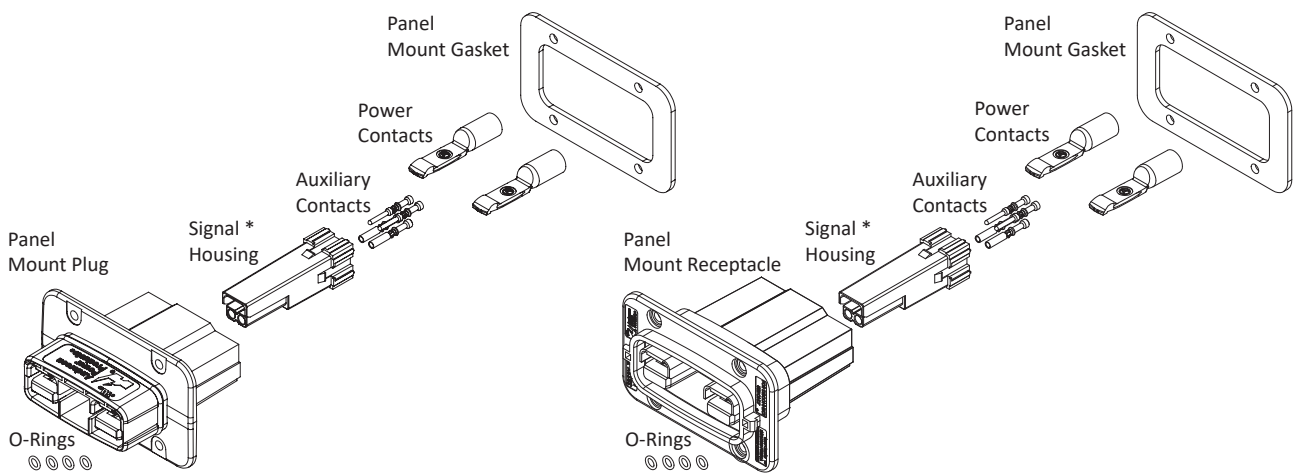

COMPONENTS - *Center Ground Housing & Contact

Wire-to-Wire

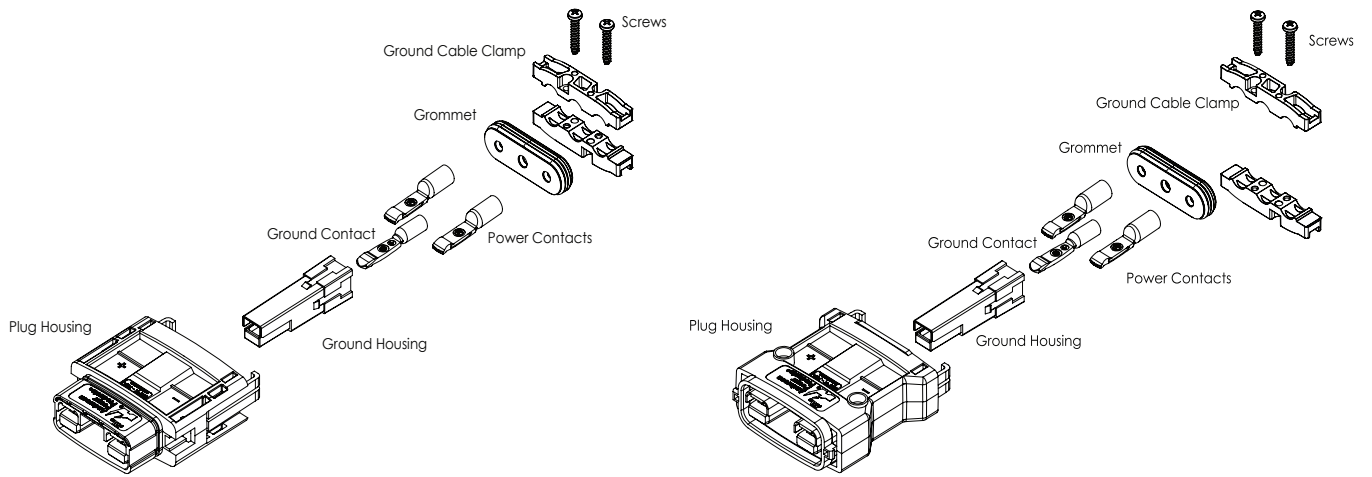

Wire-to-Panel Mount

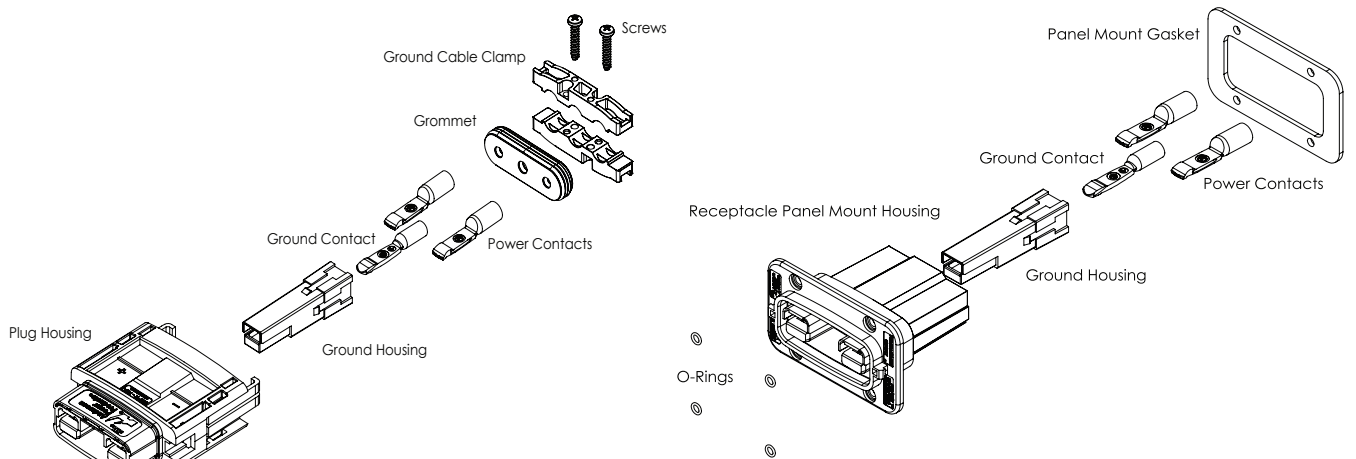

Panel Mount-to-Panel Mount

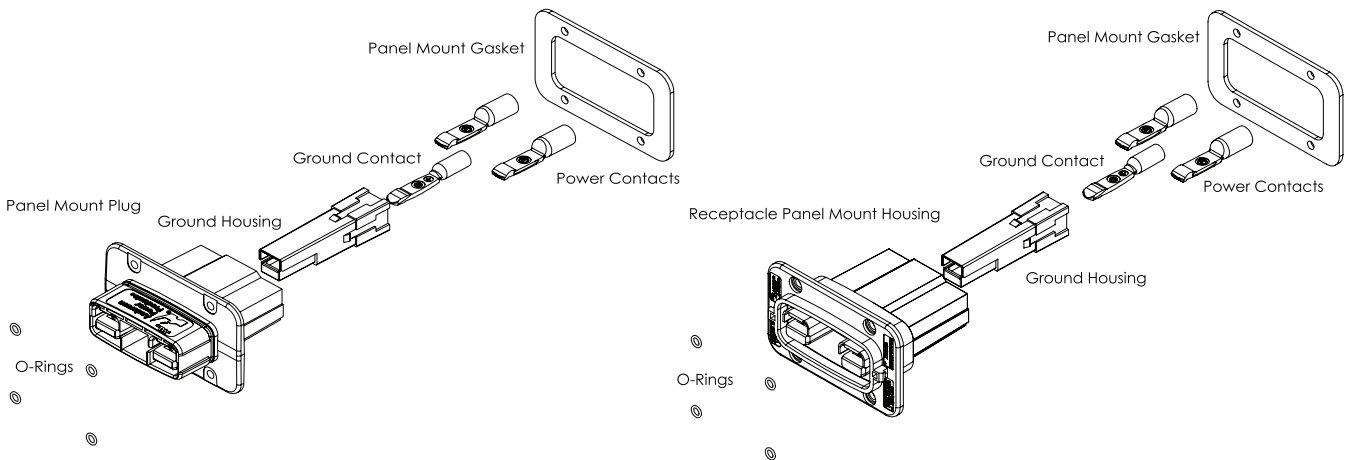



ORDERING INFORMATION - Color denotes signal or ground housings only. All other housings are black. Signal housings are available in 4 or 6 position styles. 6 position utilizes PPMX contacts. Ground utilizes ground contacts.





Step 1: Select the Housing Kit - Packaged as Individual Kits. Contacts and Grommets Sold Separately, See Step 2 & 3

Image	Part Number	Description- Sealed SBS®X-75A	Kit Includes- Housing, Signal Housing and Below Parts
	Minimum Quantity		1
	SBSX75A-PLUG-KIT-RED	Male Plug - Red	Latches, Cable Clamp, Hardware & Front O-Rings
	SBSX75A-PLUG-KIT-BLU	Male Plug - Blue	Latches, Cable Clamp, Hardware & Front O-Rings
	SBSX75A-PLUG-KIT-GRA	Male Plug - Gray	Latches, Cable Clamp, Hardware & Front O-Rings
	SBSX75A-PLUG-KIT-BLK	Male Plug - Black	Latches, Cable Clamp, Hardware & Front O-Rings
	SBSX75A-6AUX-PLUG-KIT-WHT	6 Position Auxiliary Male Plug - White	6 Position Signal Housing, Contact Holder, Latches, Cable Clamp, Hardware & Front O-rings
	SBSX75A-GND-PLUG-KIT-GRN	Male Plug- Green (Ground)	Ground Housing, Latches, Cable Clamp, Hardware & Front O-Rings
	SBSX75A-REC-KIT-RED	Female Receptacle - Red	Cable Clamp, Hardware
	SBSX75A-REC-KIT-BLU	Female Receptacle - Blue	Cable Clamp, Hardware
	SBSX75A-REC-KIT-GRA	Female Receptacle - Gray	Cable Clamp, Hardware
	SBSX75A-REC-KIT-BLK	Female Receptacle - Black	Cable Clamp, Hardware
	SBSX75A-6AUX-REC-KIT-WHT	6 Position Auxiliary Female Receptacle - White	6 Position Signal Housing, Contact Holder, Cable Clamp, Hardware
	SBSX75A-GND-REC-KIT-GRN	Female Receptacle - Green (Ground)	Ground Housing, Cable Clamp, Hardware
	SBSX75A-PMREC-KIT-RED	Panel Mount Receptacle - Red *	Panel Gasket, Mounting O-Rings
	SBSX75A-PMREC-KIT-BLU	Panel Mount Receptacle - Blue *	Panel Gasket, Mounting O-Rings
	SBSX75A-PMREC-KIT-GRA	Panel Mount Receptacle - Gray *	Panel Gasket, Mounting O-Rings
	SBSX75A-PMREC-KIT-BLK	Panel Mount Receptacle - Black *	Panel Gasket, Mounting O-Rings
	SBSX75A-6AUX-PMREC-KIT-WHT	6 Position Auxiliary Panel Mount Receptacle - White	6 Position Signal Housing, Contact Holder, Panel Gasket, Mounting O-Rings
	SBSX75A-GND-PMREC-KIT-GRN	Panel Mount Receptacle - Green (Ground)*	Ground Housing, Panel Gasket, Mounting O-Rings

Step 1: Continued

Image	Part Number	Description- Sealed SBS®X-75A	Kit Includes- Housing, Signal Housing and Below Parts
Minimum Quantity			1
	SBSX75A-PMPLUG-KIT-RED	Panel Mount Plug - Red *	Front O-Ring, Panel Gasket, Mounting O-Rings
	SBSX75A-PMPLUG-KIT-BLU	Panel Mount Plug - Blue *	Front O-Ring, Panel Gasket, Mounting O-Rings
	SBSX75A-PMPLUG-KIT-GRA	Panel Mount Plug - Gray *	Front O-Ring, Panel Gasket, Mounting O-Rings
	SBSX75A-PMPLUG-KIT-BLK	Panel Mount Plug - Black *	Front O-Ring, Panel Gasket, Mounting O-Rings
	SBSX75A-6AUX-PMPLUG-KIT-WHT	6 Position Auxiliary Panel Mount Plug - White	6 Position Signal Housing, Contact Holder, Front O-Ring, Panel Gasket, Mounting O-Rings
	SBSX75A-GND-PMPLUG-KIT-GRN	Panel Mount Plug - Green (Ground) *	Ground Housing, Front O-Ring, Panel Gasket, Mounting O-Rings

Bulk Component Ordering Information - All components sold separately. For grommets and contacts, see step 2 & 3.



Image	Part Number	Description- Sealed SBS®X-75A	Includes
Minimum Quantity			100
	SBSX75A-PLUG-BLK	Male Plug Housing	Housing, Latches & O-Rings
	SBSX75A-REC-BLK	Female Receptacle Housing	Housing
	SBSX75A-PMREC-BLK	Panel Mount Receptacle Housing	Housing
	SBSX75A-PMPLUG-BLK	Panel Mount Plug Housing *	Housing, Front O-Ring

* Panel Mount Plug mates with Panel Mount Receptacle for Panel-to-Panel applications. Please note that this configuration has not been tested for Ingress protection ratings, please contact the manufacturer for further details on this requirement to see if it will work for your application needs. Panel Mount hardware not included.

Step 1 Continued - Bulk Components Continued

	Minimum Quantity		200
	2-8840P1	Signal Housing - Red	Housing
	2-8840P2	Signal Housing - Blue	Housing
	2-8840P3	Signal Housing - Gray	Housing
	2-8840P4	Signal Housing - Black	Housing
	2-8862P1	Ground Housing- Green	Housing
	2-8860P1	6 Position Signal Housing- White	Housing
	2-8859P1	6 Position Contact Holder- Black	Contact Holder
	2-8841P1	Cable Clamp	Cable Clamp (set of two)
	2-8863P1	Ground Cable Clamp	Cable Clamp (set of two)
	H1120P62	#4 to 20 5/8" (15.88 mm) Plastite Head Screws - Cable Clamp	Screws
	108G1	Panel Mount Hardware Kit	Panel Mount Gasket, Mounting O-Rings

Covers - Use When Parts are Unmated for IP68 Protection

Image	Part Number	Description- Sealed SBS®X-75A	Includes
Minimum Quantity			1
	SBSX75A-PLUG-COVER	Plug Cover *	Housing, Lanyard
	SBSX75A-REC-COVER	Receptacle Cover	Housing, Latches, O-Ring, Lanyard
	SBSX75A-PMREC-COVER	Panel Mount Receptacle Cover	Housing, Latches, O-Ring, Lanyard

* Inquire with Manufacturer or Sales Representative regarding panel mount plug covers

IP68



Dust - Water - Shock Protection

Step 2: Grommets Sold Separately

To select proper grommet size, you will need to know the outer diameter of jacketed cable for each of the Power and Signal cables. Find your overall power size, then determine appropriate outer dimension for both Power and Signal cables. Not using signal, then select NS grommet that matches your power only size. Panel mount housings do not require grommets.

Discrete Wires



Discrete Wire
Power & Signal

Part Number	Wire Size AWG	Wire Size mm ²	Power Wire Diameter Range (mm ²)	Signal Cable / Wire Size Diameter Range (mm ²)
D-150-060	10 to 12	2.5 to 6	0.15 to 0.18 (3.81 to 4.57)	0.08 to 0.10 (2.03 to 2.54)
D-310-060	6 to 4	16	0.31 to 0.34 (7.87 to 8.64)	0.08 to 0.10 (2.03 to 2.54)

Jacket Cable



Jacket Cable
Power & Signal



Power Only

Part Number	Wire Size AWG	Wire Size mm ²	Power Wire Diameter Range (mm ²)	Signal Cable / Wire Size Diameter Range (mm ²)
Minimum Quantity 1				
J-150-150	10 to 12	2.5 to 6	0.15 to 0.18 (3.81 to 4.57)	0.15 to 0.18 (3.81 to 4.57)
J-150-180	10 to 12	2.5 to 6	0.15 to 0.18 (3.81 to 4.57)	0.18 to 0.21 (4.57 to 5.33)
J-150-320	10 to 12	2.5 to 6	0.15 to 0.18 (3.81 to 4.57)	0.32 to 0.35 (8.13 to 8.89)
J-150-350	10 to 12	2.5 to 6	0.15 to 0.18 (3.81 to 4.57)	0.35 to 0.38 (8.89 to 9.65)
J-150-380	10 to 12	2.5 to 6	0.15 to 0.18 (3.81 to 4.57)	0.38 to 0.41 (9.65 to 10.41)
J-150-410	10 to 12	2.5 to 6	0.15 to 0.18 (3.81 to 4.57)	0.41 to 0.44 (10.41 to 11.18)
NS-150	10 to 12	2.5 to 6	0.15 to 0.18 (3.81 to 4.57)	No Signal
J-240-150	8	10	0.24 to 0.27 (6.10 to 6.86)	0.15 to 0.18 (3.81 to 4.57)
J-240-180	8	10	0.24 to 0.27 (6.10 to 6.86)	0.18 to 0.21 (4.57 to 5.33)
J-240-240	8	10	0.24 to 0.27 (6.10 to 6.86)	0.24 to 0.27 (6.10 to 6.86)
J-240-320	8	10	0.24 to 0.27 (6.10 to 6.86)	0.32 to 0.35 (8.13 to 8.89)
J-240-350	8	10	0.24 to 0.27 (6.10 to 6.86)	0.35 to 0.38 (8.89 to 9.65)
J-240-380	8	10	0.24 to 0.27 (6.10 to 6.86)	0.38 to 0.41 (9.65 to 10.41)
J-240-410	8	10	0.24 to 0.27 (6.10 to 6.86)	0.41 to 0.44 (10.41 to 11.18)
NS-240	8	10	0.24 to 0.27 (6.10 to 6.86)	No Signal
J-310-150	6	16	0.31 to 0.34 (7.87 to 8.64)	0.15 to 0.18 (3.81 to 4.57)
J-310-180	6	16	0.31 to 0.34 (7.87 to 8.64)	0.18 to 0.21 (4.57 to 5.33)
J-310-310	6	16	0.31 to 0.34 (7.87 to 8.64)	0.31 to 0.34 (7.87 to 8.64)
J-310-320	6	16	0.31 to 0.34 (7.87 to 8.64)	0.32 to 0.35 (8.13 to 8.89)
J-310-350	6	16	0.31 to 0.34 (7.87 to 8.64)	0.35 to 0.38 (8.89 to 9.65)
J-310-380	6	16	0.31 to 0.34 (7.87 to 8.64)	0.38 to 0.41 (9.65 to 10.41)
J-310-410	6	16	0.31 to 0.34 (7.87 to 8.64)	0.41 to 0.44 (10.41 to 11.18)
NS-310	6	16	0.31 to 0.34 (7.87 to 8.64)	No Signal
J-410-150	4	25	0.41 to 0.44 (10.41 to 11.18)	0.15 to 0.18 (3.81 to 4.57)
J-410-180	4	25	0.41 to 0.44 (10.41 to 11.18)	0.18 to 0.21 (4.57 to 5.33)
J-410-320	4	25	0.41 to 0.44 (10.41 to 11.18)	0.32 to 0.35 (8.13 to 8.89)
J-410-350	4	25	0.41 to 0.44 (10.41 to 11.18)	0.35 to 0.38 (8.89 to 9.65)
J-410-380	4	25	0.41 to 0.44 (10.41 to 11.18)	0.38 to 0.41 (9.65 to 10.41)
J-410-410	4	25	0.41 to 0.44 (10.41 to 11.18)	0.41 to 0.44 (10.41 to 11.18)
NS-410	4	25	0.41 to 0.44 (10.41 to 11.18)	No Signal

NOTE: Don't see your cable size requirements? Speak to Manufacturer or your local Representative about other options regarding custom grommets.

Step 3: Contacts Sold Separately for Power, Ground and Signal

Silver Plated Primary Power Wire Contacts

SBS®X-75A housings use two silver plated contacts per housing for the best electrical performance and durability up to 10,000 mating cycles.

Description	AWG	mm ²	Part Numbers- Loose Piece		Diameter - A-	
					inches	mm
Minimum Quantity			1,000	100		
Standard	4	25	1339G4-BK	1339G4 *	0.28	7.11
	6	16	1339G2-BK	1339G2 *	0.22	5.60
	8	10	1339G5-BK	1339G5 *	0.19	4.70
	12 to 10	2.5 to 6	1339G3-BK	1339G3 *	0.14	3.50

* Are sold as pairs. 2 contacts ship for every 1 ordered.

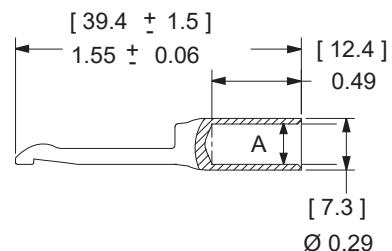
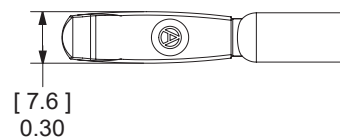

Silver Plated Pre-Mate Wire Contacts

Pre-Mate contacts used for grounding are for the center Pre-Mate position on the SBS®-X75A wire housings.

Description	AWG	mm ²	Part Numbers- Loose Piece		Diameter - A-	
					inches	mm
Minimum Quantity			500	50		
Pre-Mate	6	16	1340G1-BK	1340G1	0.22	5.60
Pre-Mate	8	10	1340G2-BK	1340G2	0.19	4.70
Pre-Mate	12 to 10	2.5 to 6	1340G3-BK	1340G3	0.14	3.50

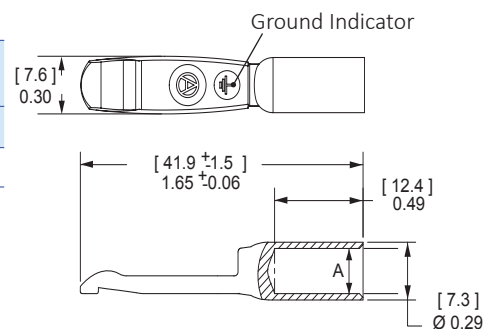

Pin Contacts for Auxiliary 4 Positions

Gold plated contacts are available in 3 lengths to allow sequencing of circuits.

Description	AWG	mm ²	Part Numbers
Minimum Quantity			500
Standard Length 7.7 mm	16 to 14	1.0 to 1.5	PM16P1416S30
	20 to 16	0.75 to 1.0	PM16P1620S30
	24 to 20	0.50 to 0.75	PM16P2024S30
Pre-Mate 9.3 mm	16 to 14	1.0 to 1.5	PM16P1416A30
	20 to 16	0.75 to 1.0	PM16P1620A30
	24 to 20	0.50 to 0.75	PM16P2024A30
Post-Mate 6.4 mm	16 to 14	1.0 to 1.5	PM16P1416C30
	20 to 16	0.75 to 1.0	PM16P1620C30
	24 to 20	0.50 to 0.75	PM16P2024C30

Auxiliary Pin Contact Lengths

	- L -		- L1 -	
	in.	mm	in.	mm
Standard Length 7.7 mm	0.77	19.6	0.30	7.7
Pre-Mate 9.3 mm	0.83	21.2	0.37	9.3
Post-Mate 6.4 mm	0.72	18.3	0.25	6.4

See drawings on website for further details.

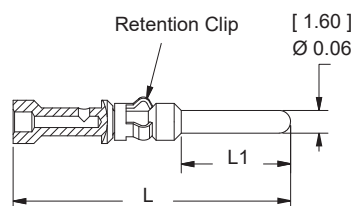

Socket Contacts 4 Position Auxiliary

Selective gold plated contacts offer low resistance and durability up to 10,000 mating cycles.

Description	AWG	mm ²	Part Numbers
Minimum Quantity			500
Socket Contacts	16 to 14	1.0 to 1.5	PM16S1416S32
	20 to 16	0.75 to 1.0	PM16S1620S32
	24 to 20	0.50 to 0.75	PM16S2024S32

Auxiliary Socket Contacts Crimp Barrel ID

AWG	in.	mm.
16 to 14	0.08	2.1
20 to 16	0.07	1.7
24 to 20	0.04	1.1

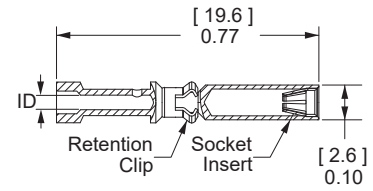

See drawings on website for further details.

Pin & Socket Contacts PPMX 6 Position Auxiliary Connector

Gold plated contacts are ideal for signal or low power use with durability up to 5,000 mating cycles.

Description	AWG	mm ²	Part Numbers
Minimum Quantity			2,000 50
Pin Contacts	24 to 20	0.50 to 0.25	4803G3-BK 4803G3
Socket Contacts	24 to 20	0.50 to 0.25	4802G3-BK 4802G3

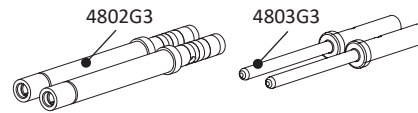

NOTE: Contacts sold individually, not sold as a set of two.

SBS® TOOLING INFORMATION ⁵

Tools

1387G1
Other die locators
available per above



TP0001



1309G4



PM1000G1



PM1003G1



PM1003GX



11038G3



PM1002G1



116081P17



Wire Size		Power Contacts								
AWG	mm ²	Power Contact Part Number	Pneumatic Bench Tool	+	Die	+	Locator	Number of Crimps	OR	Hand Tool
4	25.0	1339G4	1387G1		1388G6		1389G9	Single		N/A
6	16	1339G2	1387G1		1388G6		1389G9	Single		1309G4
8	10	1339G5			1388G7					
12 to 10	2.5 to 6	1339G3								

Wire Size		Ground Contact								
AWG	mm ²	Contacts	Pneumatic Bench Tool	+	Die	+	Locator	Number of Crimps	OR	Hand Tools
6	16	1340G1	1387G1		1388G6		1389G20	Single		1309G4
8	10	1340G2								
12 to 10	2.5 to 6	1340G3				1388G7				

Wire Size		Auxiliary Contacts - 4 Position									
AWG	mm ²	Contacts	Pneumatic Bench Tool ⁶	+	Die	+	Locator for: TM0001 & TP0001	Mil Std. Hand Tool ⁶ M22520/1-01	Number of Crimps	OR	APP® Hand Tool w/ Integral Locator
14 to 24	1.5 to 0.50	All Crimp Pins	TP0001		N/A		TL0001	TM0001	Single		PM1000G1
		All Crimp Sockets				TL0002					

Tools	
Auxiliary Contact Insertion Tool: PM1002G1	Wire Sizes 24 to 16 AWG (0.50 to 1.00mm ²)
Auxiliary Contact Insertion Tool: 11038G3	Wire Size 14 AWG (1.5mm ²)
Auxiliary Contact Extraction Tool: PM1003G1	
Auxiliary Contact Insertion Inspection Tool: PM1003GX	
Signal Housing Extraction Tool: 116081P1 ⁷	

Wire Size		PPMX Auxiliary Contacts - 6 Position								
AWG	mm ²	Contacts	Pneumatic Bench Tool	+	Die	+	Locator	Number of Crimps	OR	Hand Tools
20 to 24	0.50 to 0.25	4803G3	TP0001*		N/A		TL0005	Single		TM0001* or
		4802G3		PM1000G1						

* TP0001 and TM0001 tools require locators to properly position contacts.

NOTES:

6 - The use of Anderson Power tooling is strongly recommended. The use of alternate tools may adversely affect the performance of our connectors along with UL and CSA recognition.

7 - TP0001 and TM0001 tools require locators TL0001 for Pins and TL0002 for Sockets. The Auxiliary contacts used with wire sizes 14 to 24 AWG (1.5 to 0.50) cannot be properly inserted without the insertion tool. Properly installed Auxiliary contacts of all wire gauges cannot be removed from the housing without the extraction tool. It is highly recommended that inspection tool be used to ensure the auxiliary contacts are seated properly in the housing.

8 - The Signal Housing Extraction Tool must be used in order to remove the signal housing from the main housing should position be inserted incorrectly for mating. See assembly instructions for further information.



5,000 Mating Cycles

BUILD YOUR PART NUMBER

Step 1

Housings (including signal) - Center signal housings available in 4 or 6 positions or ground housings.

Cable Clamp

Screw

Panel Mount Kit

Covers

Step 2

Grommets

Step 3

Power / Ground Contacts

Signal Contacts (4 or 6 Position)

Tooling

All Data Subject to Change Without Notice 2023-0119 DS-SBSX75A REV 4 **Your Best Connection™**

Anderson™ will use reasonable efforts to include accurate and up-to-date content in the data sheet. All product information contained in the data sheet including ordering information, illustrations, specifications, and dimensions, are believed to be reliable as of the date of publishing, but is subject to change without notice. Anderson™ makes no warranty or representation as to its accuracy. Content in the data sheet may contain technical inaccuracies, typographical errors and may be changed or updated without notice. Anderson™ may also make improvements and/or changes to the products and/or to the programs described in the content at any time without notice. Current sales drawings and specifications are available upon request.

©2023 Anderson Power Products, Inc. All rights reserved. A®, SBS® and Anderson Power Products® are registered trademarks of Anderson Power Products, Inc. Anderson™, Anderson Power™, Anderson Power™ logo, and Your Best Connection™ are trademarks of Anderson Power Products, Inc.



HEADQUARTERS: Anderson Power Products®, 13 Pratts Junction Road, Sterling, MA 01564-2305 USA T: +1 978-422-3800 F: +1 978-422-0128 • **EUROPE:** Anderson Power Products® Ltd., Unit 3, Europa Court, Europa Boulevard, Westbrook, Warrington, Cheshire, WAS 7TN United Kingdom T: +44 (0) 1925 428390 F: +44 (0) 1925 520203
• **GERMANY:** IDEAL® Industries Germany GmbH, Esslinger Strasse 7, D – 70771 Leinfelden-Echterdingen, T: +49 (0) 711 – 997606666 • **ASIA / PACIFIC:** IDEAL® Anderson Asia Pacific Ltd., Unit 922-928 Topsail Plaza, 11 On Sum Street, Shatin N.T., Hong Kong T: +(852) 2636 0836 F: +(852) 2635 9036 • **INDIA:** IDEAL® INDUSTRIES India Private Limited, 229-230, SPAZEDGE, Tower B, Sector 47, Sohna Road, Gurgaon – 122018, Haryana, India T: +(91) 956-0075905 T: +(91) 124-4495101 • **CHINA:** IDEAL® Anderson Technologies (Shenzhen) Ltd., Block A8 Tantou Western Industrial Park, Songgang Baoan District, Shenzhen, PR. China 518105 T: +(86) 755 2768 2118 F: +(86) 755 2768 2218
• www.ideal-industries.in • www.andersonpower.com